

User Manual

Grid-Connected PV Inverter

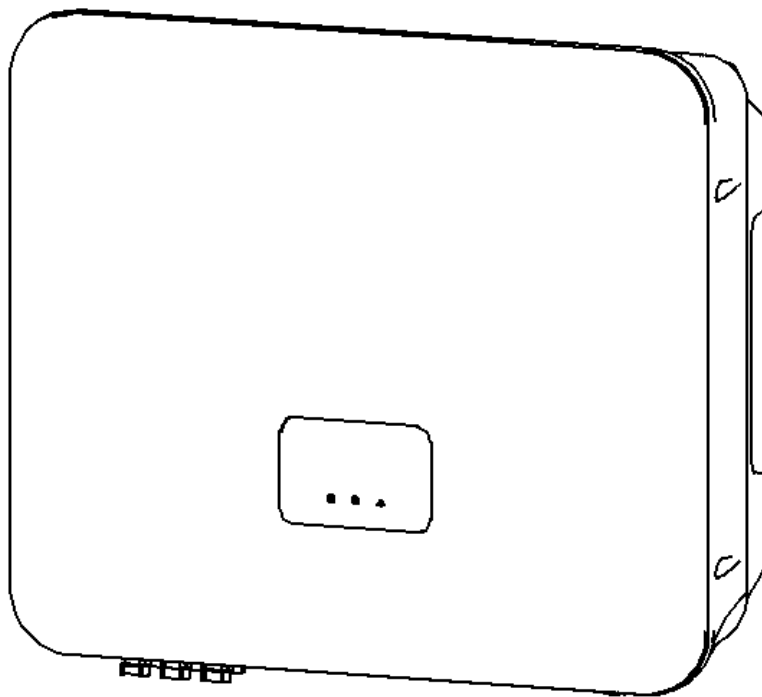

**EA5KTSI/ EA6KTSI/ EA8KTSI/ EA10KTSI/
EA13KTSI/ EA16KTSI**

Legal Disclaimer

- No all or part of this document may be reproduced, stored in a retrieval system, or transmitted, in any form or by any means, without the prior written permission of our company.
- The products, services or features you purchased shall be subject to the commercial contract and terms. All or part of the products, services or features described in this document may not be within the scope of your purchase or use. Unless otherwise specified in the contract, no presentation is made or warranty, either express or implied, as to the contents of this document.
- As standards, specifications, and designs change from time to time, the information in this document is subject to change without notice. Every attempt has been made to make this document complete, accurate and up-to-date. Readers are cautioned, however, that our company reserves the right to make changes without notice. All statements, information, and recommendations in this document do not constitute a warranty of any kind, express or implied.





Table of Contents

1	General Information.....	1
1.1	Safety Messages	1
1.2	Validity	2
1.3	Safety Precautions	2
2	Product Overview	4
2.1	Components of PV Grid-Connected System	4
2.2	Schematic Diagram	5
2.3	Appearance of Inverter.....	5
2.4	Weights and Dimensions of Inverter	6
2.5	Specifications.....	6
3	Unpacking and Storage	8
3.1	Unpacking Inspection	8
3.2	Storage	8
4	Installation	10
4.1	Mounting Location	10
4.2	Mounting the Inverter	11
5	Electrical Connection.....	13
5.1	Safety Precautions	13
5.2	Cable Requirements	13
5.3	DC Connection	14
5.4	AC Connection	15
5.5	Second Protective Earth Connection	17
5.7	Connection of Anti-Backflow Meter (Optional).....	18
6	Installing the Communication Module	20
7	Operation	22
7.1	Switching On.....	22
7.2	Switching Off	22
7.3	LED Indicator Lights	22
7.4	Auto test function (For Italy)	23
8	Monitoring	25
8.1	Professional Edition App.....	25
8.2	Home Edition App	29
9	Troubleshooting for Fault Messages Displayed on APP	32















1 General Information

1.1 Safety Messages

Read the manual carefully to become familiar with the equipment before trying to install, operate, service or maintain it. The following safety messages may appear throughout this manual or on the equipment to warn of potential hazards.

	DANGER DANGER indicates a hazardous situation which, if not avoided, will result in death or serious injury.
	WARNING WARNING indicates a hazardous situation which, if not avoided, could result in death or serious injury.
	CAUTION CAUTION indicates a potentially hazardous situation which, if not avoided, could result in minor or moderate injury.
	NOTICE NOTICE is used to address practices not related to physical injury, but to property damage.
	NOTE NOTE is additional information in the manual, which is emphasis and supplement to the contents and provides prompts that are valuable for the optimal installation and operation.

This manual and device may also use the following electrical symbols and identification, shown as follows:

Symbol	Description	Symbol	Description
	DC		Voltage negative pole
	AC		Voltage positive pole
	Earth (Ground)		Off (Power supply)
	Protective earth		On (Power supply)
	Frame or chassis terminal		Refer to the manual description
	Caution, risk of electric shock		Warning of danger
	Caution, hot surface		Danger alert of electric shock. Energy storage timed discharge (time to be indicated adjacent to the symbol)

1.2 Validity

This manual is valid for the following residential three phase on-grid PV inverters (hereinafter referred to as inverter):

5kW/6kW/8kW/10kW/13kW/16kW

1.3 Safety Precautions

Follow the precautions and special safety instructions provided in the manual when operating the products. Our company will not be liable for any consequences that are caused due to violations regarding general safety regulations and equipment design, production, and usage safety standards.

Anti-islanding protection:

Shifting the frequency of the inverter away from nominal conditions in the absence of a reference frequency (frequency shift) .

Disclaimer

Our company shall not be liable for any consequence caused by any of the following events:

- Damage caused by transportation
- Storage conditions that do not meet the requirements specified in this document
- Incorrect storage, installation, or use
- Installation or use by unqualified personnel
- Failure to comply with the operation instructions and safety precautions in this document
- Operation in extreme environments which are not specified in this document
- Operation beyond specified ranges
- Unauthorized modifications to the product or software code or removal of the product
- Device damage due to force majeure (such as lightning, earthquakes, fire, and storms)
- Warranty expiration without extension of the warranty service
- Installation or use in environments which are not specified in related international standards

	DANGER! High voltage may result in death or serious burns!
	<ul style="list-style-type: none">● Operations on the inverter must be performed by qualified personnel.● PV arrays exposed to light may generate dangerous voltage.● Do not touch the electriferous modules in the PV system while the inverter is running.● Carefully read the safety precautions in this manual.

DANGER! Do not touch the contacts or terminals connected to the grid or the equipment, or it may result in electric shock to death or outbreak of a fire!
--

	<ul style="list-style-type: none"> • Do not touch the terminals or conductors connected to the grid circuit. • Read and understand all instructions and safety precautions for grid connection. • Follow all the safety precautions for low voltage power grid.
---	--

	DANGER! The damaged device or system fault may result in electric shock or outbreak of a fire!
	<ul style="list-style-type: none"> • Check if there is damage or other dangerous conditions for the device before operation. • Check if the external device and circuit connection are in a safe state. • Make sure the device is in a safe state for operating.

	WARNING!
	<ul style="list-style-type: none"> • The inverter can be connected to the grid only if it gets permission from the local electric power department. • All electrical installations must be made in accordance with national and local standards and regulations.

	WARNING! Operation by non-professional may result in death or severe burns.
	<ul style="list-style-type: none"> • Only trained electrically qualified persons are permitted to do electrical operation on this product. • During maintenance, it is necessary to ensure that at least two staff members work in the field; the breakers of AC terminal and DC terminal must be fully disconnected for at least 10 minutes for internal energy storage components discharging completely, which should be confirmed with a voltmeter.

	NOTICE! Contact or improper operation on printed circuit board or other electrostatic sensitive components may result in damage to the components.
	<ul style="list-style-type: none"> • Avoid unnecessary contacts with circuit boards. • Comply with electrostatic protection standards, wear an antistatic wrist strap.

- When installing PV arrays during the day, opaque material should be used to cover the solar battery arrays, otherwise, the solar array will generate high voltage under sunlight.
- The input DC voltage must not exceed 1000 V, and the excessive voltage may result in damage to the device.
- The inverter must be properly transported, stored, assembled, installed, operated and maintained.
- All operations and wiring must be made by qualified personnel only to ensure that all electrical installations meet the electrical installation standards. In order to ensure safe operation, the device should be grounded properly and provided with necessary short circuit protection.
- Ensure that DC side and AC side have no electric charge before maintaining or

checking the inverter.

- The capacitor in the inverter may present a shock hazard even all connections of the inverter are disconnected. Therefore, the device should be maintained and operated after turning off the inverter for at least 10 minutes.
- Follow all the instructions in this manual.
- The inverter will generate heat during operating, do not touch the radiator and other hot components of the inverter during operating to avoid burns.

2 Product Overview

2.1 Components of PV Grid-Connected System

PV grid-connected system consists of PV modules, PV grid-connected inverters, metering device and power distribution system. The solar energy is converted into DC via PV modules, and then the DC is converted into sinusoidal AC which has the same frequency and phase as the utility grid and fed into the utility grid via inverters.

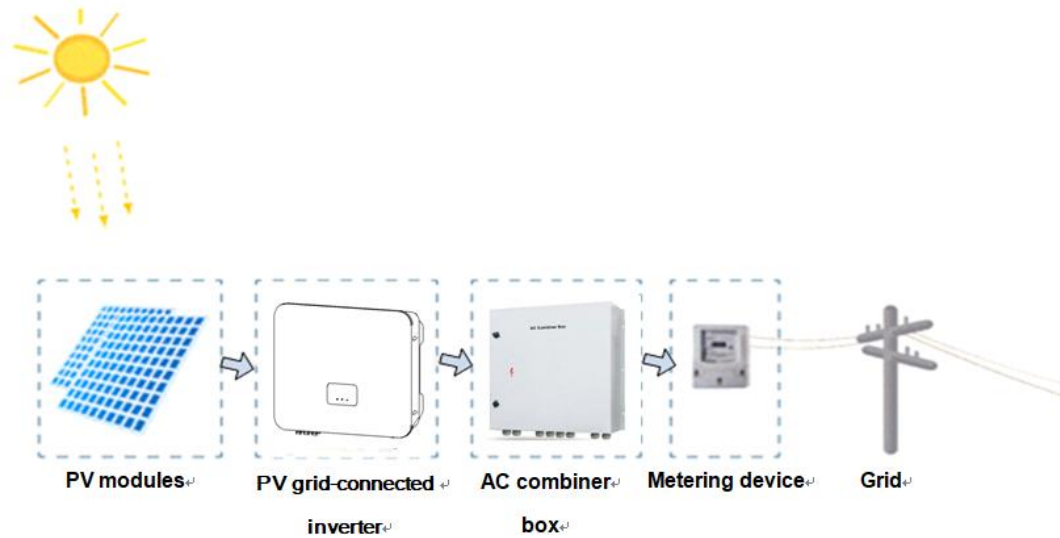

Components	Description
A PV modules	Monocrystalline silicon, polycrystalline silicon, and thin-film batteries with II level protection and no need to be grounded
B Inverter	5kW/6kW/8kW/10kW/13kW/16kW
C Electric meter	Standard measuring tools for inverter output power
D Utility grid	TT, TN-C, TN-S, TN-C-S

2.2 Schematic Diagram

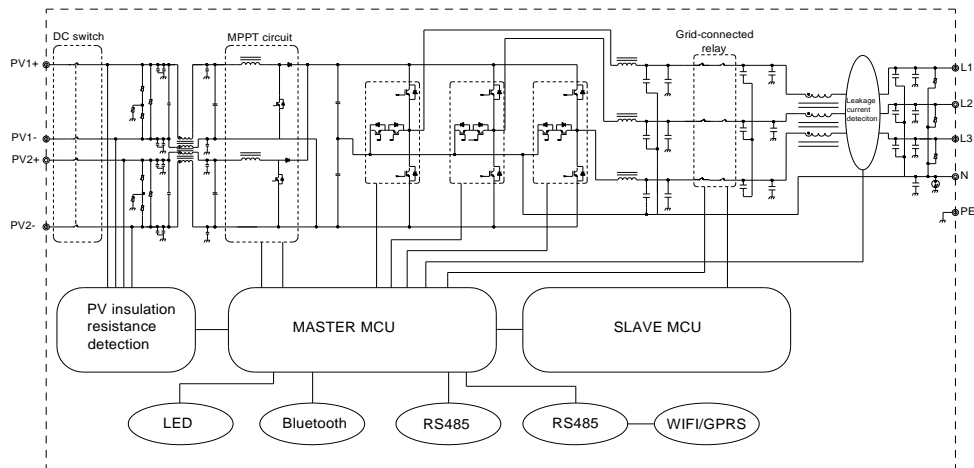

 **Note:** The inverter topology consists of boost and inversion. PV input feeds into the public power grid via DC filtering, boosting, DC bus decoupling, inverter and AC filtering. It adopts DSP and MCU dual-chip redundancy technology to realize fault detection and protection of the inverter. The interior of the inverter has two groups of relays connected between the inverter circuit output and power grid port, and the groups of relays have self-test function that can ensure reliable disconnecting of the connection between the inverter circuit and the utility grid in the event of a failure. It realizes the remote monitoring of the PV power generation system via the communication methods of RS485, GPRS and Wi-Fi.

2.3 Appearance of Inverter

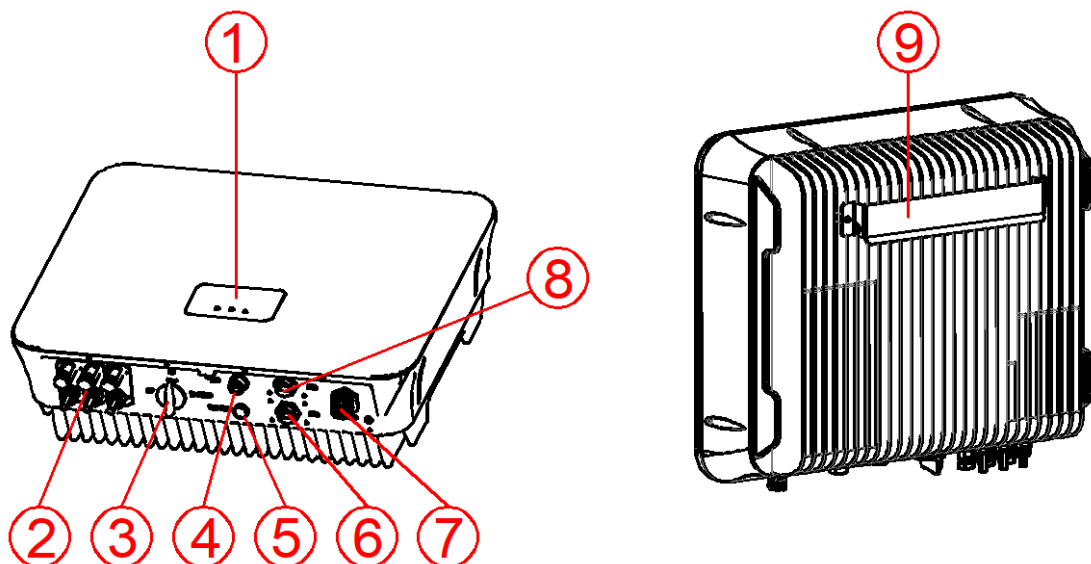

No.	Description	Explanation
①	LED display panel	To display the inverter running state / communication status

②	DC input terminals	To connect inverter to PV modules
③	DC switch	To directly control DC input On / Off
④	Communication terminals	To connect Wi-Fi or other communication module
⑤	Ventilation valve	To prevent from condensing and fogging, and balance differential pressure between inside and outside the cabinet
⑥	DRM communication	Interface of demand response modes for Australia grid dispatching
⑦	AC output terminals	To feed the inverter output energy into the grid
⑧	Ammeter communication and digital input	Input interface for electric meter communication and external digital input
⑨	Mounting bracket	To fix the inverter on the wall mounting bracket

2.4 Weights and Dimensions of Inverter

Inverters	Weight	Dimensions (WxDxH)
5kW/6kW/8kW/10kW/13kW/16kW	25 kg	515 mm x 166.5 mm x 435 mm

Dimensions of 5kW/6kW/8kW/10kW/13kW/16kW inverter:

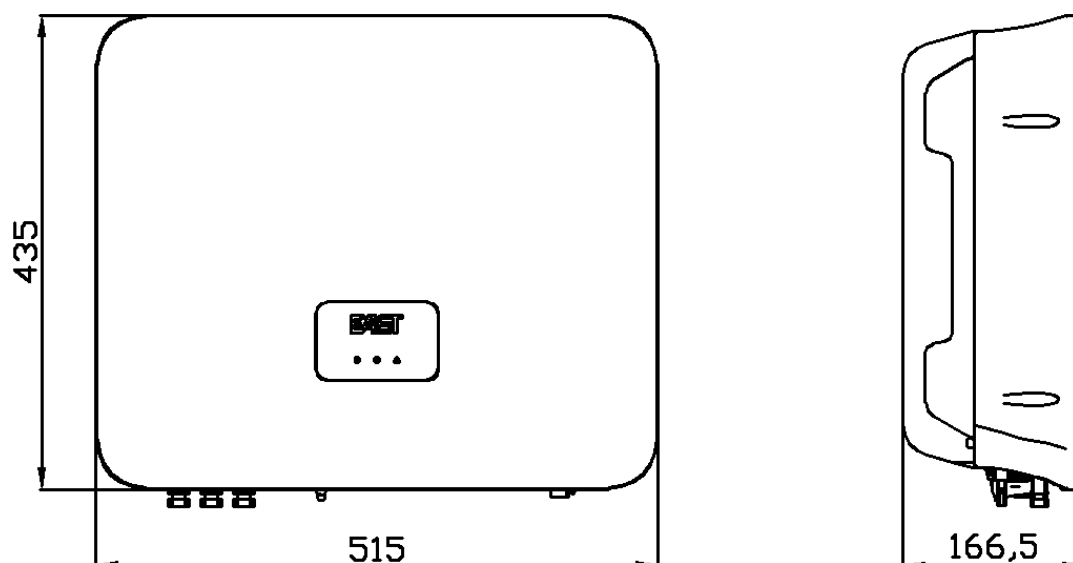

2.5 Specifications

MODEL	EA5KTSI	EA6KTSI	EA8KTSI	EA10KTSI	EA13KTSI	EA16KTSI
-------	---------	---------	---------	----------	----------	----------

INPUT(DC)						
Max.input power	6.5kW	7.8kW	10.4kW	13kW	16.9kW	20.8kW
Max.input voltage	1000V					
Start-up voltage	180V			250V		
MPPT voltage range	120-950V			200-950V		
MPPT voltage range at full load	250-850V	280-850V	380-850V	470-850V	410-850V	500-850V
Max. input current	11A/11A			11×2A/11A		
Max. short circuit current	12A/12A			12×2A/12A		
Number of MPPTs	2					
Number of DC inputs	A:1/B:1			A:2/B:1		
OUTPUT(AC)						
Rated output power	5kW	6kW	8kW	10kW	13kW	16kW
Max. active power	5kW	6kW	8kW	10kW	13kW	16kW
Max. apparent power	5kVA	6KVA	8kVA	10kVA	13kVA	16kVA
Max. output current	7.3A	8.7A	11.6A	14.5A	18.9A	23.2A
Rated grid voltage	230/400V,3W+N+PE					
Grid voltage range	176-276V/304-480V					
Rated grid frequency	50/60Hz					
Gird frequency range	45-55/55-65Hz					
THD	<3%(rated power)					
Output current DC component	<0.5%In					
Power factor	>0.99(rated power)					
Power factor adjustable	0.8 leading~0.8 lagging					
EFFICIENCY						
Max. efficiency	98.65%					
European efficiency	98.2%					
PROTECTION						
DC switch	Available					
DC reverse polarity protection	Available					
Ground insulation resistance detection	Available					
Leakage current protection	Available					
Output overcurrent protection	Available					
Output overvoltage protection	Available					
Anti- islanding protection	Available					
DC surge protection	Class III lightning protection					
AC surge protection	Class III lightning protection					
PID protection and repair	Optional					
OTHERS						
0-95% non-condensing						
Display	LED, bluetooth					
Communication	RS485,Wi-Fi(optional),GPRS(optional)					
Safety Standard	NB/T 32004, IEC62109-1, IEC62109-2					
EMC standard	NB/T 32004, EN 61000-6-1, EN 61000-6-2, EN 61000-6-3, EN 61000-6-4					

Self-consumption at night	<1W
Isolation	transformerless
IP rating	IP65
Operating temperature	-25°C + 60°C (> 45°C downgrading)
Relative humidity	0~100%(no condensation)
Cooling	Natural cooling
Altitude	4000m >(2000m downgrading)
Dimensions (W*D*H) [mm]	515*166.5*435
Weight [kg]	25



Note: The above specifications are for reference only, please prevail in kind in the event of any inconsistency.

3 Unpacking and Storage

3.1 Unpacking Inspection

Although the product has been rigorously tested and inspected before delivery, damage may still occur during transport. Check that the delivery is complete, check the packaging and the inverter for externally visible damage, and inspect the package contents upon receipt. Notify the carrier and dealer if any damage is found or any component is missing.

Scope of delivery:

No.	Designation	Quantity
1	Grid-Connected PV inverter	1 pcs
2	User manual	1 pcs
3	Quick guide	1 pcs
4	PV input terminal	3 sets
5	AC output terminal	1 set
6	Communication module (Wi-Fi)	1 set
7	Expansion screws	3 sets
8	Hexagon socket screws with spring and plain washer	1 pcs
9	Outer hex-cross screw with spring and plain washer	1 pcs
10	Wall mounting bracket	1 pcs
11	Waterproof terminal	2 set

3.2 Storage

If the inverter is not immediately put into operation, it needs to be stored in a specific environment:

- The inverter needs to be repackaged with the original packaging and the desiccant is retained. The packaging box needs to be sealed with tape.
- The inverter should be stored in a clean and dry place that free from dust and water vapor erosion.
- The temperature of the storage place should be kept at -30°C - +85°C and the

- relative humidity should be maintained between 0 and 100% without condensation.
- If the inverter should be stacked, it is recommended that the maximum number of layers can be accumulated no more than 5 layers.
 - The inverter must avoid the corrosive chemicals, otherwise it may be corroded.
 - It needs regular inspection during the storage, and the packaging materials should be replaced timely in the case of damage by rats and vermin.
 - Do not tilt or invert the packaging box.
 - After long-term storage, the inverter can't be put into operation until the comprehensive inspection and testing is made by qualified personnel.

4 Installation

4.1 Mounting Location

	DANGER! Danger to life due to fire or explosion!
	<ul style="list-style-type: none">• Do not mount the inverter on flammable construction materials.• Do not install the inverter in areas where highly flammable materials are stored.• Do not install the inverter in areas with a risk of explosion.

In order to ensure that the inverter operates properly, the installation environment and requirements are as follows:

- The inverter is intended for outdoor use with IP 65 rating. The installation location should be cool and in good ventilation. Do not expose the inverter in the direct sunlight, otherwise, it may result in excessive temperature rise inside the inverter, downgrading operation of protection circuit and even shutdown due to over-temperature fault.
- Rain and snow do impact on the service life of the inverter, do not install the inverter in the rain and snow or do some appropriate shelter.
- The inverter adopts natural cooling, the ventilation and cooling are very important. Do not install the inverter in a closed enclosure, otherwise the inverter should be too hot to operate or even damaged.
- The inverter should be installed in the reinforced concrete wall or metal wall that can bear the weight of the inverter. The inverter must be installed vertically. Ensure that the installation place does not shaking.
- The inverter operation will generate some noise (< 40 dB), it should be installed away from the residential areas. Ensure that the installation location is convenient for viewing LED lights and LCD display screen. Sufficient clearances around the inverter must be reserved for ventilation, cooling, installation, maintenance and safe access.
- Do not install the inverter outdoors in salt areas because it will be corroded there and may cause fire. A salt area refers to the region within 500 meters from the coast or prone to sea breeze. The regions prone to sea breeze vary depending on weather conditions (such as typhoons and monsoons) or terrains (such as dams and hills).

	CAUTION
	Ambient temperature range shall be -25°C to +60°C. It will affect the inverter output power when the temperature exceeds the limit.
	Environmental relative humidity must be in the range of 0% ~ 100%.

4.2 Mounting the Inverter

4.2.1 Clearance

Note: Only install the inverter vertically or tilted backwards no more than 15 degrees. Do not tilt or install the inverter horizontally. The wiring terminal should be downwards.

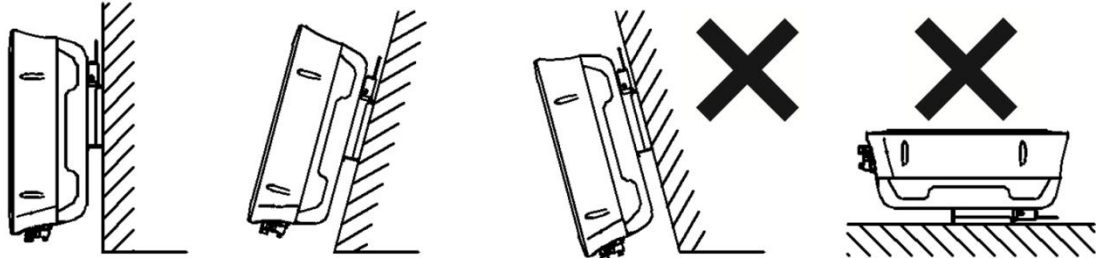

In order to maintain sufficient ventilation, when installing the inverter a minimum clearance of 30 cm at the sides and 50 cm at the top must be maintained. Operation and reading are made easier by installing the inverter with its display at eye level and by keeping a distance of 100 cm from the front. All cables are routed to the outside through the underside of the enclosure, therefore a minimum clearance of 50 cm must be observed here.

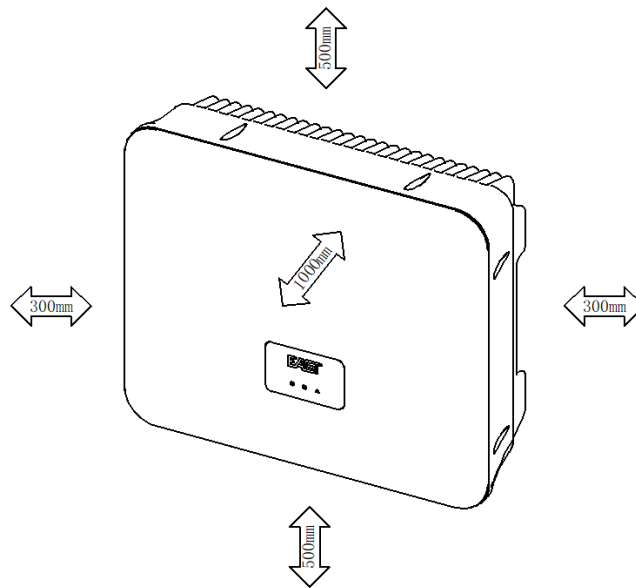

4.2.2 Installation Procedure

1. Place the wall mounting bracket against a suitable wall for mounting and align using a level. Mark the position of the drill holes using the wall mounting bracket.
2. Drill holes on the markings for them.
3. Secure the wall mounting bracket to the wall using expansion screws. Tighten the screws with a minimum torque of 30Nm, and M6 x 50 expansion bolts are recommended for use.

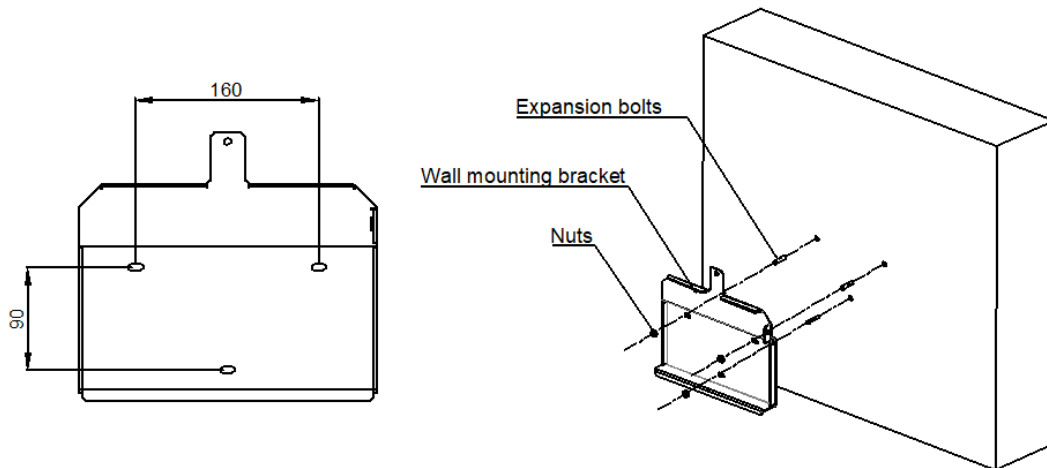

4. Attach the inverter to the wall mounting bracket. Screw the inverter to the wall mounting bracket on both sides using the M5 screws provided. Tighten the screws and make sure that they are securely in place.

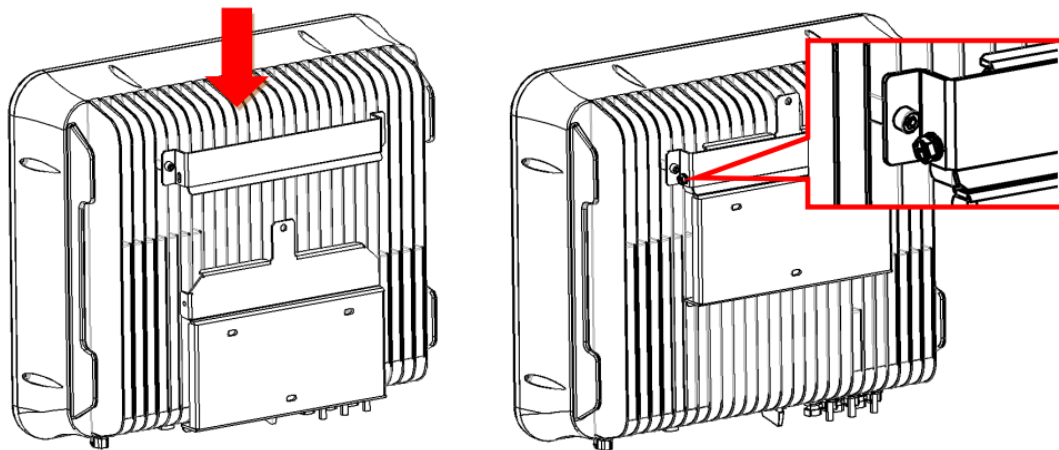

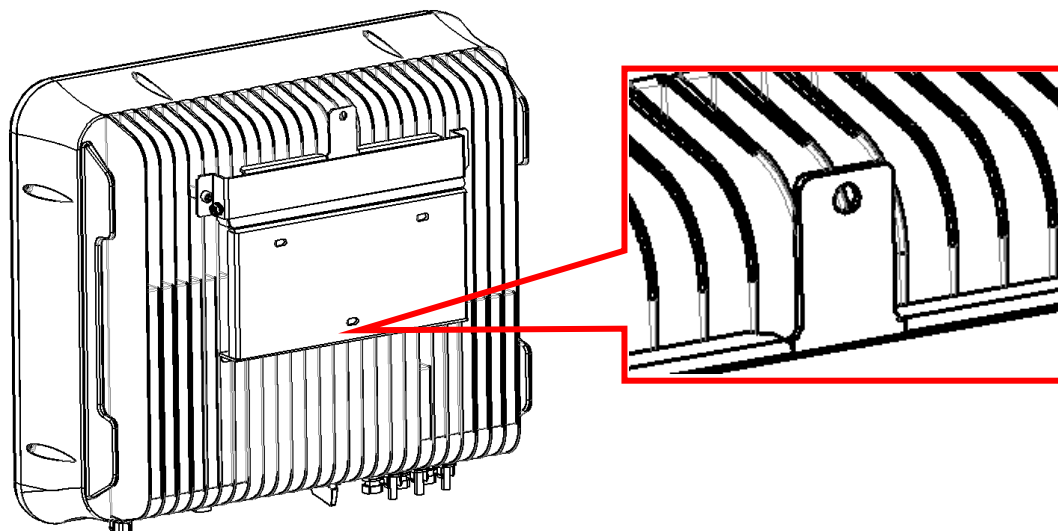

5. The Wall mounting bracket reserved a padlock hole to prevent the inverter from being stolen. The anti-theft lock needs to be prepared by the user himself.



5 Electrical Connection

5.1 Safety Precautions

	DANGER!
	Improper wiring may result in fatal injury to operator or unrecoverable damage to the inverter. Only qualified personnel can perform the wiring operation. The breakers on the AC/DC sides of the inverter must be disconnected and the warning marks must be set before wiring.
	WARNING!
	The voltage and current parameters of the inverter must be considered when designing the PV system (see 2.5).
	WARNING!
	Ensure that the electrical connection design is in compliance with the local national and local standards.
	CAUTION
	The IP rating of this inverter is IP 65, please use the wiring terminal provided, otherwise the IP rating of the inverter may be reduced.
	CAUTION
	All cables must be connected firmly and reliably, properly insulated and avoid to be damaged easily.
	CAUTION
	The inverter can only be connected to the utility grid after getting the approval from the local electric power department.

5.2 Cable Requirements

Cable	Cable size (mm ²)
PV array DC+/DC-	Provide 6 inputs, cable diameter > 4mm ²
Power grid L1 phase	Provide single output, cable diameter > 6 mm ²
Power grid L2 phase	Provide single output, cable diameter > 6 mm ²
Power grid L3 phase	Provide single output, cable diameter > 6 mm ²
Power grid N	Cable diameter > 6 mm ²
Ground wire	Cable diameter > 6 mm ²

	Connecting the product to the electrical utility grid should be approved by the local electricity service department, and the connection and operation must be made only by qualified personnel.
---	---

5.3 DC Connection

	DANGER !
	<p>Before electrical connection, cover the PV battery modules with light-proof material and disconnect the circuit breaker on the DC side.</p>

	WARNING !
	<p>This product is a non-isolated inverter, the positive and negative electrodes of the PV module cannot be grounded, otherwise it will emit PV ISO Fault. The inverter cannot operate normally even be damaged.</p>

	CAUTION
	<p>When designing PV arrays, the open-circuit voltage of each PV string less than 1000 V must be considered, and the maximum allowable short-circuit current for each PV string is no more than 12 A.</p>

	NOTE
	<p>All models of inverters are featured with two MPPT inputs and two groups of input terminals, and two groups of PV strings can be connected to the DC side.</p>

DC connection terminals are included in scope of delivery. Please connect the DC cables selected based on the above requirements to the connector by following the steps below. (Note: During connecting, use the same color for the positive cables with a mark and use another same color for negative cables with a mark. For example, generally red cables are used for the positive terminal and black cable are used for the negative .)

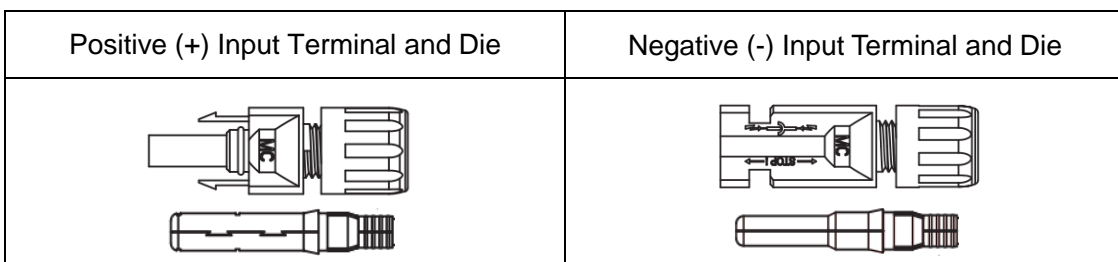
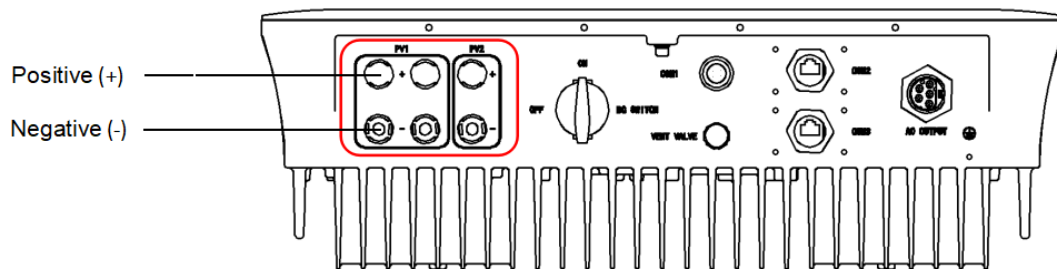



Wiring on the DC side

1. Strip the DC cable insulation about 8 mm to expose the copper wire. Insert the cable copper wire into the metal core of the connector and tighten it with a crimper (As shown in the figure below).
2. Loosen the terminal cover and pass the cable through the terminal cover. Insert the die into the wiring slot till you hear a sound indicating that the connection is in place. Tighten the terminal cover (As shown in the figure below).
3. Check whether the PV array cable connection polarity is correct with a voltmeter whose DC voltage measurement range is over 1000 V, and verify that the open-circuit voltage does not exceed the specification. When the ambient temperature is above 10°C, the open-circuit voltage of PV arrays can't exceed 90% of the maximum DC voltage of the inverter. Otherwise, at the low temperatures, the voltage of PV arrays may exceed the maximum input voltage of the inverter and cause damage to the inverter.
4. Disconnect the circuit breaker on the DC side and connect the PV input cable to the inverter separately.

5.4 AC Connection

	WARNING !
	Ensure that electrical connections are in compliance with the local national and local standards.

	WARNING !
	The uncharged metal parts in PV power generation systems consist of PV module bracket, the metal case of the inverter, which should be grounded reliably. The grounding pole should meet the standard requirements. The grounding parts of multiple inverters and PV arrays should be connected to the same grounding bus, building a reliable equipotential connection.

	CAUTION
	According to the requirement of EN50178, the right side of the inverter has a second earth terminal, which can be connected by the combination screws M4 x 8 with flat pad and spring pad.

Wiring on the AC side

1. Pass the appropriate length of cable through the waterproof connector cap and shell. Only apply to multistrand copper wire, length of the earth wire should be 5 mm longer than the live wire and zero wire. Strip the cable insulation about 7 mm (As shown in the figure below).



2. Fix L1,L2,L3,N and PE wires to the corresponding AC terminals with a screwdriver and ensure that the PE wire is properly grounded (As shown in the figure below).

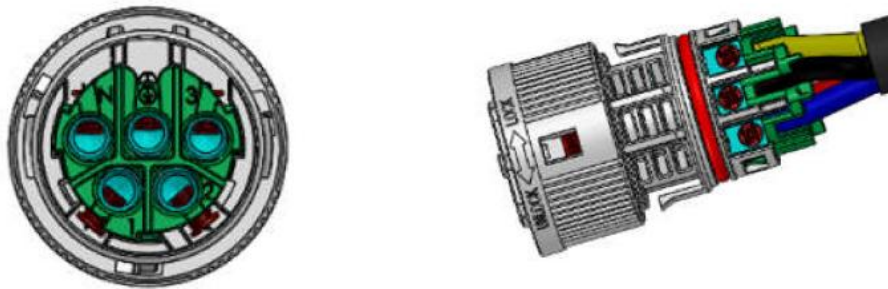

3. Insert the shell into the AC terminal, hear a sound of “click” , then tighten the waterproof connector cap.

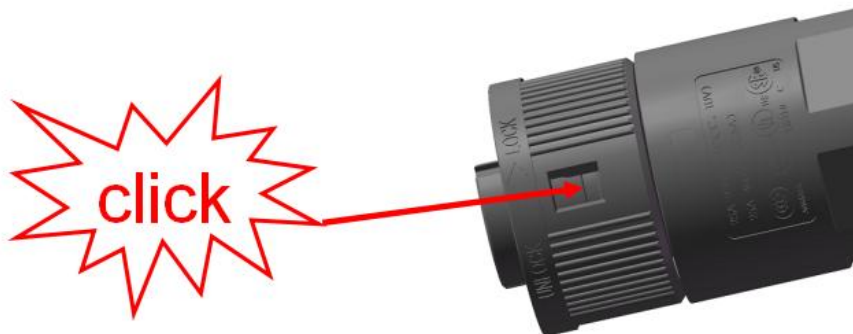

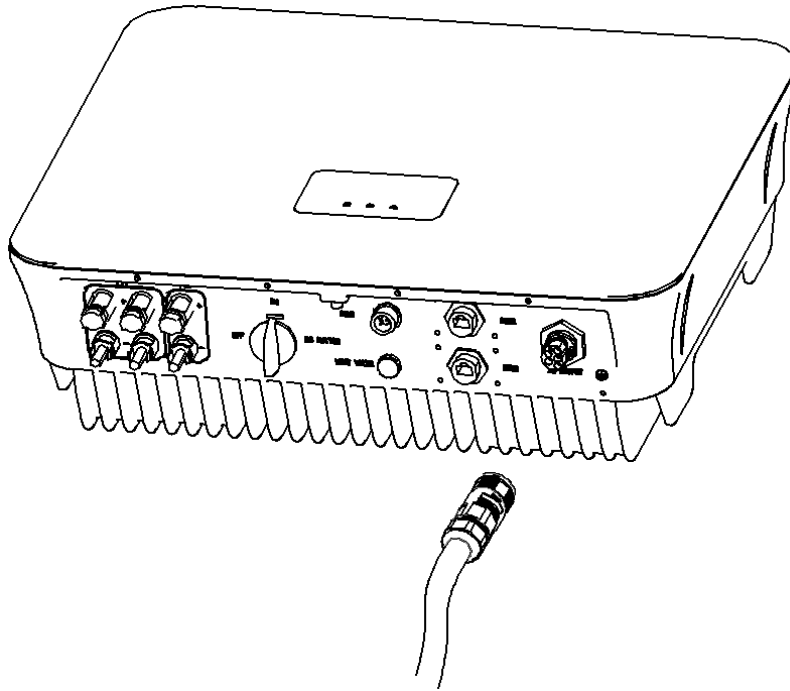

4. Push the locker onto the socket housing completely, then rotate the locker according to the direction instructed by the marks on the lock.



	CAUTION
	<p>Making the inverter output cable and installation instructions is only for reference. Please note that EA5-16KTSI output wiring is 3W + N + PE.</p>

5.5 Second Protective Earth Connection

	DANGER !
	<p>Do not connect the neutral wire to the enclosure as a PE cable. Otherwise, electric shocks could occur.</p>

	CAUTION
	<p>The PE point at the AC output port is used only as a PE equipotential point, and cannot substitute for the PE point on the enclosure.</p>

There is a protective grounding hole at the bottom of the inverter. The user must make the inverter grounded through the grounding hole and tighten it with M4*8 screws (As shown in the figure below).

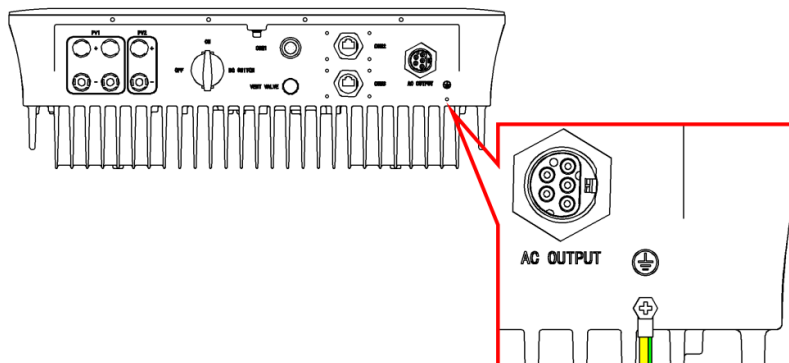

5.7 Connection of Anti-Backflow Meter (Optional)

The inverter equipped with anti-backflow function can perform power regulation and prevent feeding energy into the grid. Before using the anti-backflow function, the user should read the instructions carefully and correctly connect the cables as shown in the figure. Connection error may lead to unpredictable consequences, contact the maintenance personnel in this case.

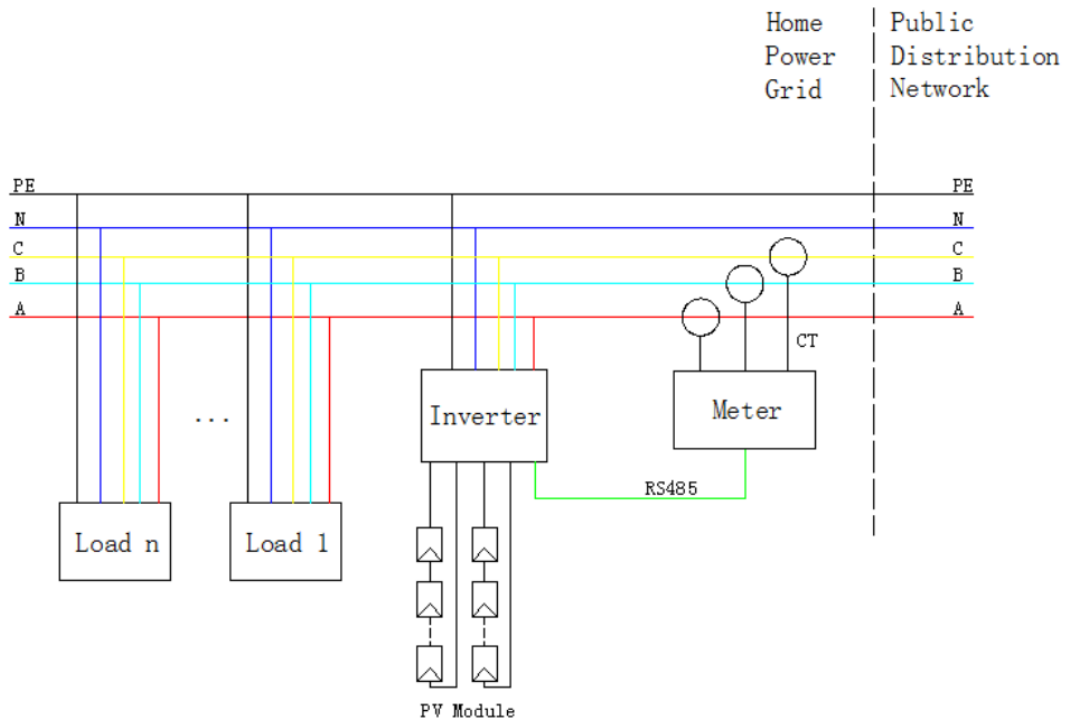

	<p>CAUTION</p>
<p>The anti-backflow meter and current transformer (CT) should be installed at the front end of the connection point between the inverter, all loads and the grid (that is, close to the public power grid). The direction of the current transformer (CT) is from the user side to the public power grid side.</p>	

Definition and wiring of the anti-backflow meter terminal are shown below.

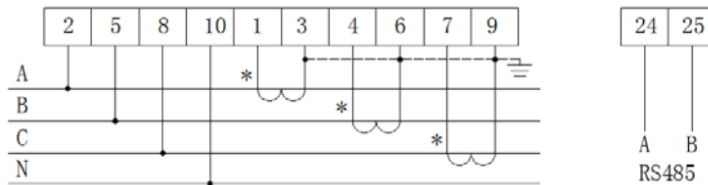
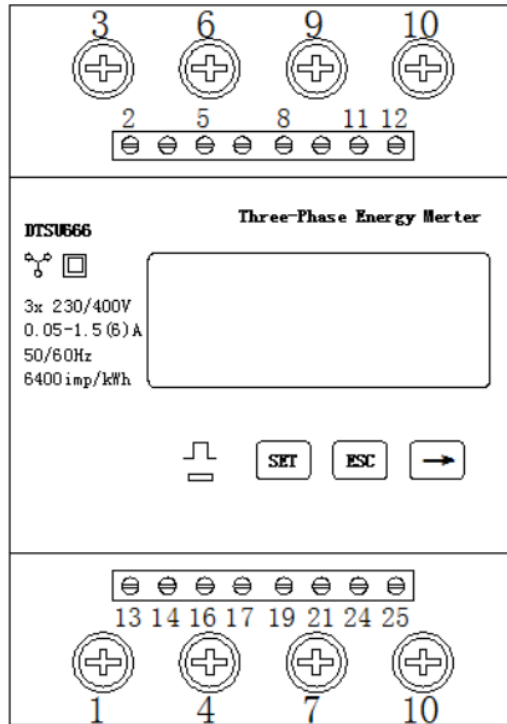

No.	Definition	Description
2	Live-A	No special requirements
5	Live-B	No special requirements
8	Live-C	No special requirements
10	Neutral	No special requirements
1	CT-Live-A	White wire
3	CT-Live-A	Black wire
4	CT-Live-B	White wire
6	CT-Live-B	Black wire
7	CT-Live-C	White wire
9	CT-Live-C	Black wire
24	RS485-A	No special requirements
25	RS485-B	No special requirements

As shown in the above figure, the anti-backflow meter terminals 24 & 25 are separately connected to the pin 8 and pin 6 of COM2.

6 Installing the Communication Module

Insert the Wi-Fi module into the COM1 communication interface at the bottom of the inverter and tighten the fastening screw.

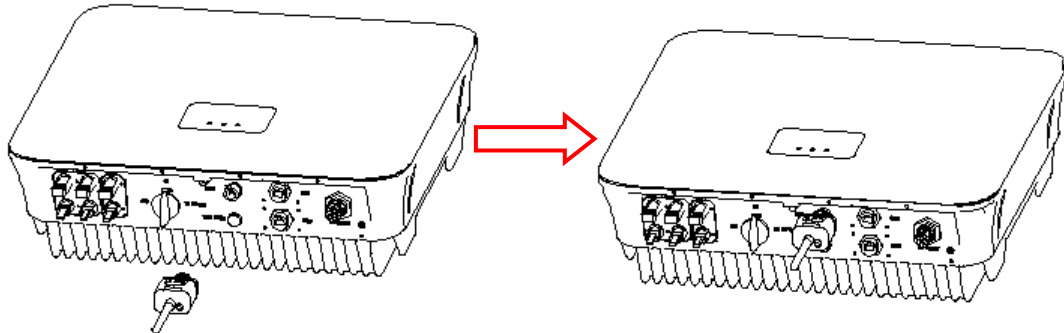

The RJ45 plug for electric meter communication and digital input is inserted into the COM2 connector, the RJ45 plug for DRM communication is inserted into the COM3 connector (only for Australian configuration).

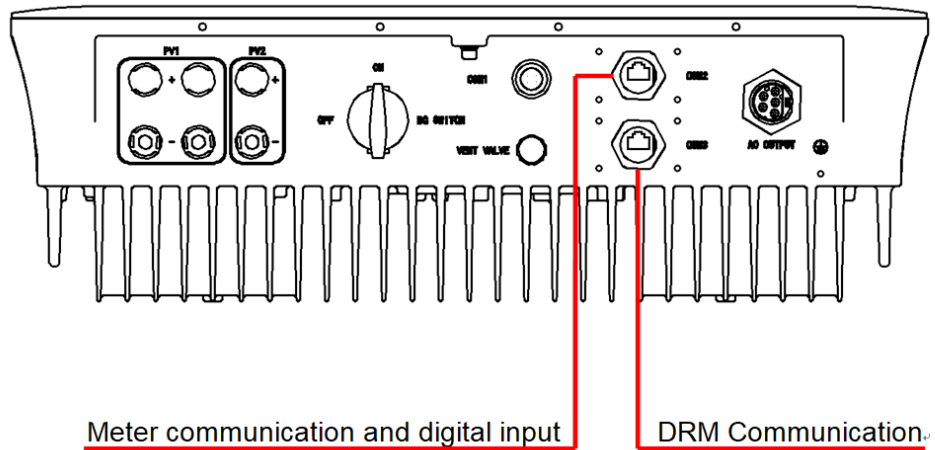

The enlarged image of the meter communication interface and DRM communication interface is as shown below:



Meter communication interface (COM2) is illustrated as follows:

Pin	1	2	3	4	5	6	7	8
Definition	Blank	Blank	DICOM1	DI 1	Blank	B2	Blank	A2

DRM communication interface (COM3) is illustrated as follows:

Pin	1	2	3	4	5	6	7	8
Definition	DRM1/5	DRM2/6	DRM3/7	DRM4/8	REF GEN/0	COM LOAD/0	Shorted blank	

The RS485 communication interface of external meter – A and B are separately connected to the pin 8 and pin 6 of COM2 to realize the communication between the inverter and meter.

CAUTION	
	<p>Make sure the waterproof cover is tightly secured when external network cables are not connected to the COM2 and COM3 interfaces.</p> <p>Please install the waterproof terminal to ensure the waterproof performance of the inverter when external network cables are connected to the COM2 and COM3 interfaces.</p>

Wiring of COM2 and COM3

1. Pass the cable through the waterproof terminal, press the RJ45 crystal plug with a crimping tool, and insert the crystal plug into the housing of waterproof terminal.

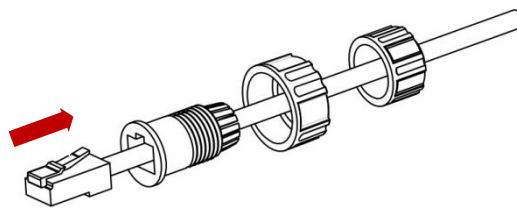

2. Insert the RJ45 crystal plug into the RJ45 port at the bottom of the inverter chassis then tighten the screw nut.

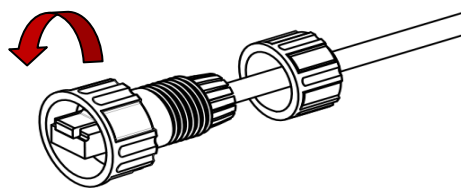

3. Tighten the sealing nut at the tail of the waterproof terminal.

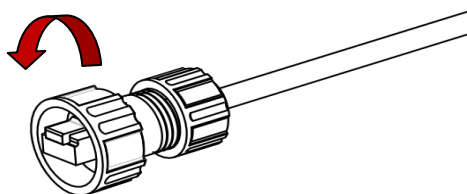

7 Operation

7.1 Switching On



1. Follow the above instructions to complete the connection of PV arrays and wiring on the AC/DC side of the inverter.
2. Before turning on the inverter, verify the following items:
 - The inverter is installed correctly and securely. The installation environment is convenient for operation and maintenance.
 - The communication module is connected correctly.
 - Electrical specifications of the AC breaker meet the requirements and it is installed correctly.
 - Cables are connected correctly, the electrified bodies are insulated and sealed to ensure safety.
 - Safety and warning labels are prominent and clear.
 - Voltage on the grid side and the DC side meet the requirements of the inverter.
3. Close the circuit breaker on the AC side.
4. Close the DC switch of the inverter. If the input voltage is within the range of requirement, the green LED indicator lights and flashes, and the inverter starts detecting.
5. When the illumination conditions meet the working requirements of the inverter, the inverter will automatically start running and deliver power to the grid. The green LED indicator is always lit.
6. There is no need to be manual controlled when the inverter is successfully connected to the utility grid and runs automatically.
7. The inverter shuts down automatically if faults occur and the red LED indicator lights. Refer to Section 7.3 for LED indicators descriptions. After the fault is removed, the inverter will restart automatically.

7.2 Switching Off

1. When the illumination is insufficient to keep the inverter running, the inverter shuts down automatically.
2. When a fault occurs, the inverter displays the fault code automatically. Disconnect the AC circuit breaker and the DC switch of the inverter if emergency shutdown is require.

7.3 LED Indicator Lights

The current status of operating and communications of the inverter can be viewed via the three LED indicator lights on the panel (as shown in following table).

LED	Display Status	Explanation
	Illuminated	Communication is normal
	Extinguish	Communication module is disconnected
	Illuminated	Inverter is in grid-connected power generation status
	Flashes at 1 second interval	Inverter is waiting for on-grid or in the started state
	Illuminated	Inverter fault
	Flashes quickly at 0.2 seconds interval	Grid fault
	Flashes slowly at 1 second interval	PV input fault

Note: If both the green LED indicator and the red LED indicator are flashing at the same time, it indicates that a program upgrade is in progress. Do not perform any operation before the program upgrade is completed.

7.4 Auto test function (For Italy)

There is only the Italian grid connection regulations requires the inverter to have a function of auto test, the follow section of 27.S1(0.85Under Voltage) is a sample introduced on how to do the inverter auto test.

Auto test procedures:

1. Install the program of sunny bee in the computer.
2. Connect the inverter communication interface of COM1 via transferring USB to RS-485 with computer.
3. Closed DC side circuit breaker and AC side circuit breaker.

Start program of sunny bee, test function of auto test as following picture.

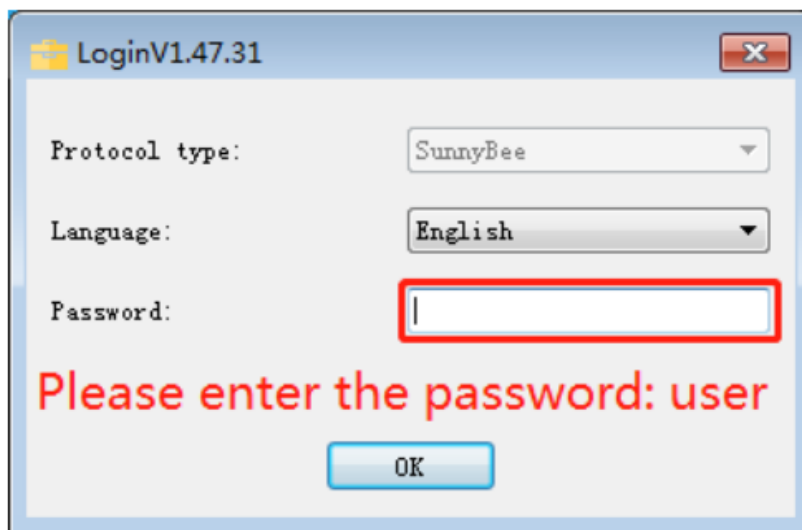

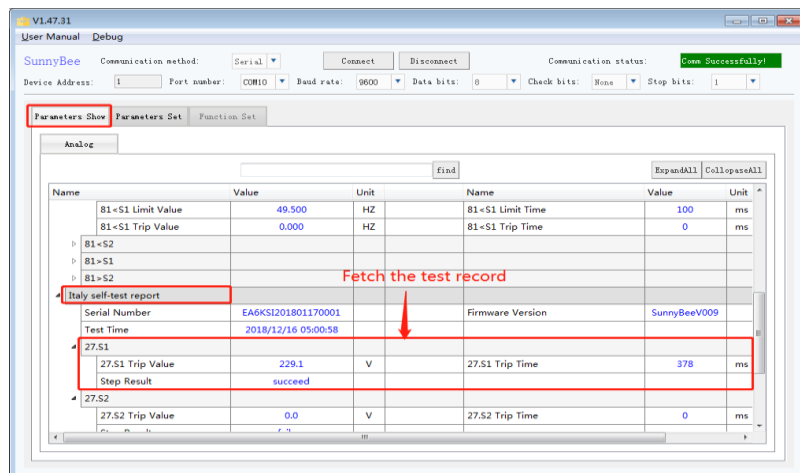
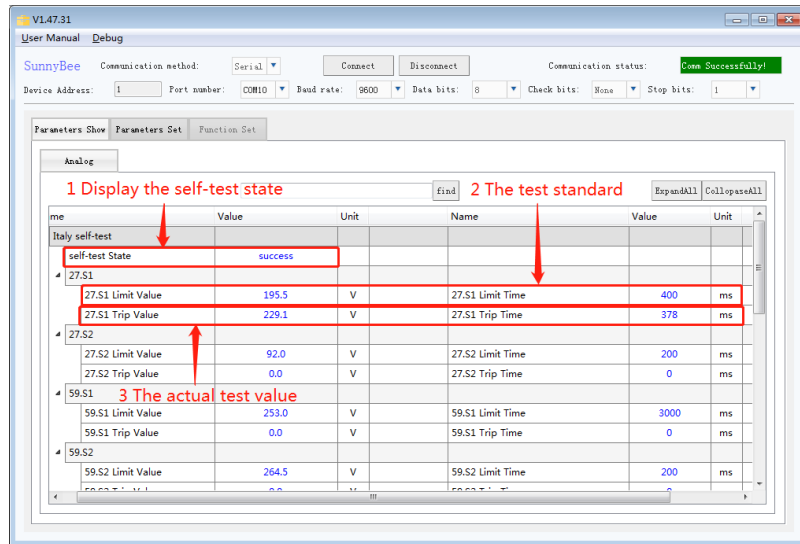
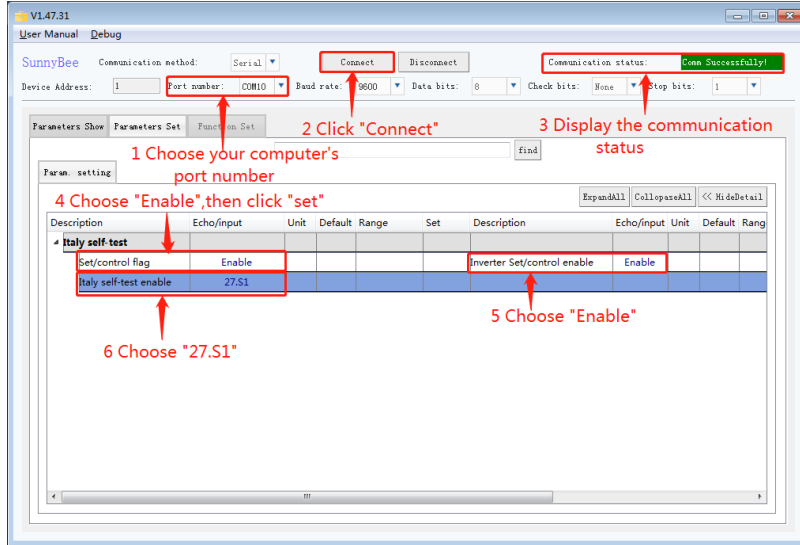

So far, the auto test is completed.

8 Monitoring

This series of inverters doesn't have an LCD display screen, therefore the wireless communication module is required to view the running state. Please refer to section 6 for the installation of wireless communication module. After installing the Wi-Fi communication module, users can download a mobile App to monitor the running state of the whole PV system.

8.1 Professional Edition App

The user can view the running status of the inverter, configure the operational parameters and upgrade the software via the professional App. Professional App is recommended for professionals, operation and maintenance personnel.

8.1.1 Software Installation

Search "solarmanPro" in Apple Store to download the App for iPhones. Search "solarmanPro" in Google Play to download the App for Android phones.

8.1.2 Registration & Login

Registration: Enter App after downloading "solarmanPro". Click on [Free Account], then enter registration information and follow [Next] procedures until [Applied], as shown below.

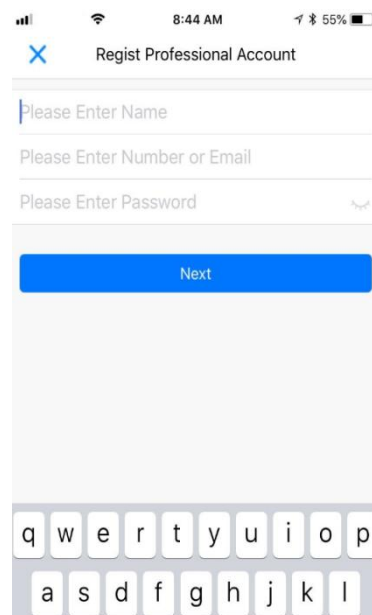
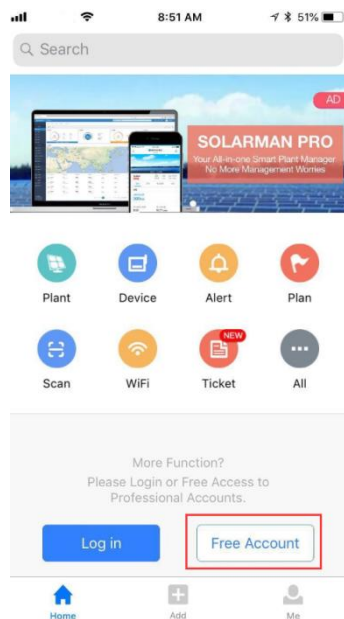

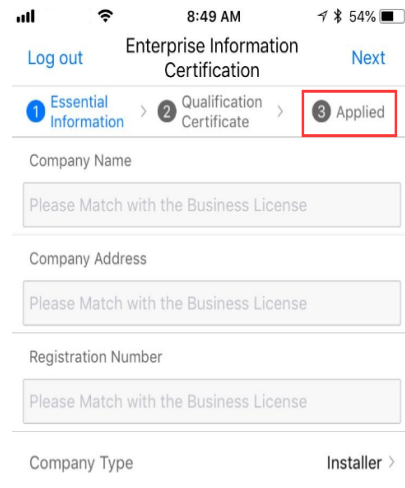
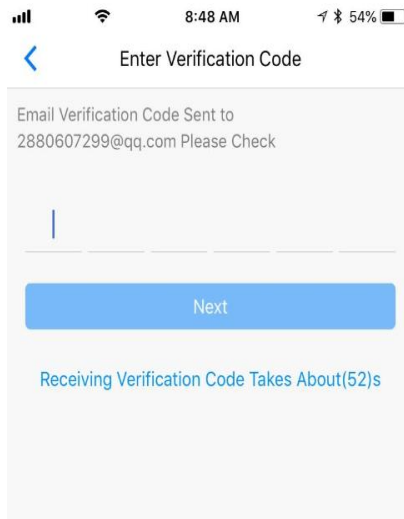

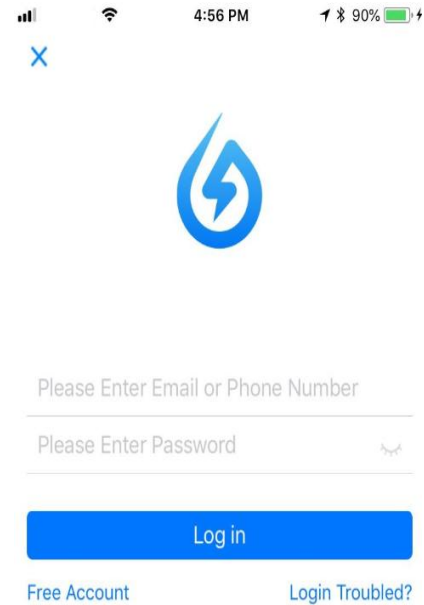
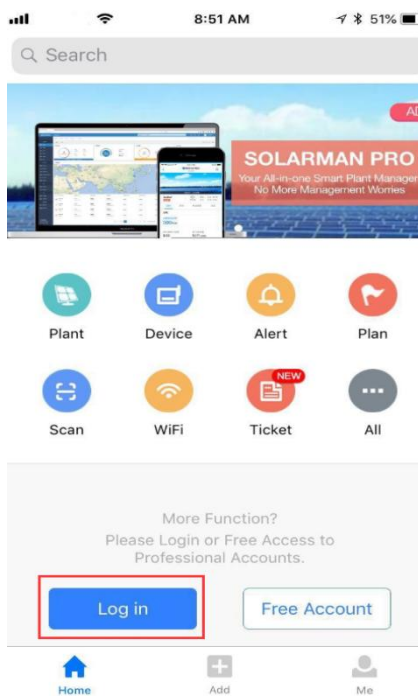

Login: Click on [Log in] in the App home page, and enter your email and password.

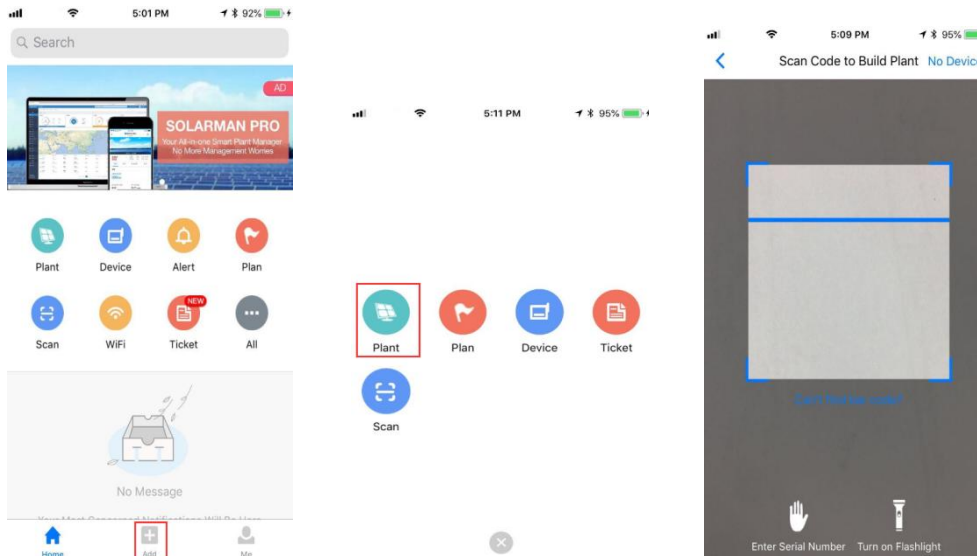

8.1.3 Create Plant

- Method 1: Click on [Add] in the App home page, and click the [Plant] icon  from the pop-up menu, then scan the serial number of the stick logger.



Method 2: click the [Plant] icon  first to enter the plant list, then click [+] in the upper right corner to add the plant, then scan the serial number of the stick logger.

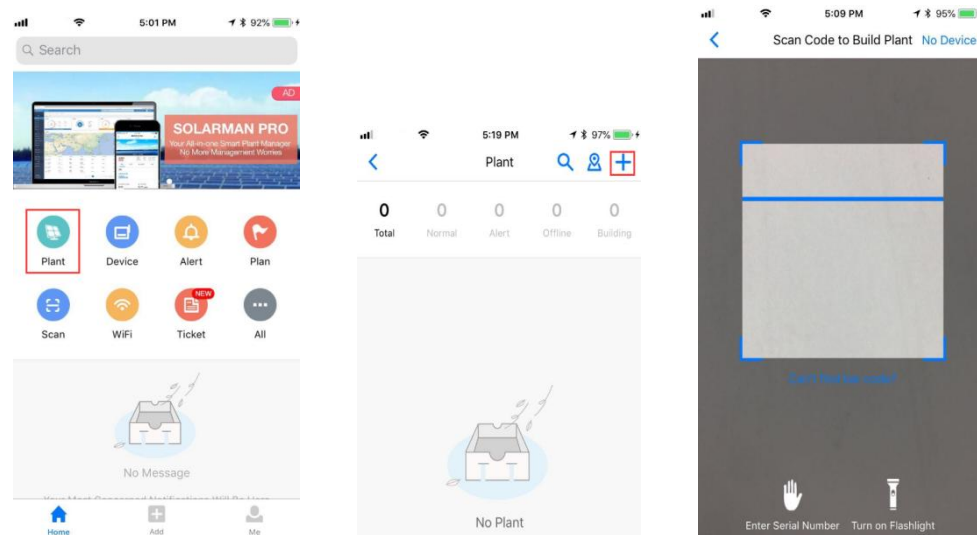

Note: If fail to scan by method 1 and method 2, you can manually enter the serial number.

2. Edit the plant information

Enter the interface of plant information after successfully scanning the serial number or clicking on [No Device].

Confirm your plant location. GPS function will automatically locate the plant site. If you are absent at the scene of the plant, or want to modify the location, click the [map] icon to find the correct plant location.

Select your plant type.

Select your grid type.

Fill in plant capacity.

(You may keep the default settings in the rest of blank because App has received local electricity prices and subsidies)

Back Ensure Plant Information Next

Plant Location

Longitude 113°54'24" LOC Map
 Latitude 22°58'5"

Plant Address

NO. No.6 Building B Gongye North Road Gu...

Plant Type

Home Industrial Business Utility

On-grid Type

Distributed Rest Poer on Grid Distributed All Power on Grid
 Ground Plant All Power on Grid Offline Storage System

Capacity(kWp) 5

3. Enter the plant name. It is suggested to create a plant name like "location + name + capacity", then click on [Done].

Back Enter Plant Name Done

Please Enter Plant Name

Contact(to contact owners)

4. Then the plant you added is shown on the homepage.

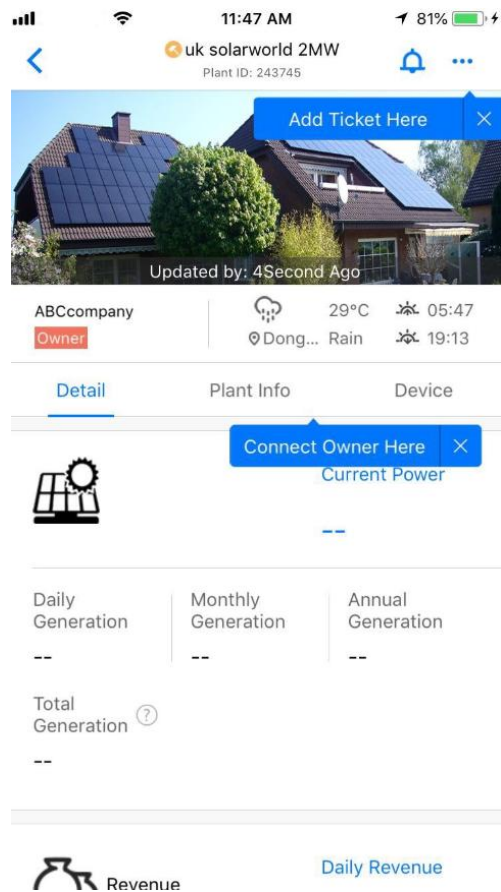

8.2 Home Edition App

Home edition APP is mainly used for residential PV system. It collects power generation information and operation information to enable users to obtain the running status information of the inverter in time.

8.2.1 Software Installation

Search “solarman” in Apple Store to download the App for iPhones, Search “solarman” in Google Play to download the App for Android phones.

8.2.2 Registration & Login

Click on [Register] to create new account, and enter your email to register.

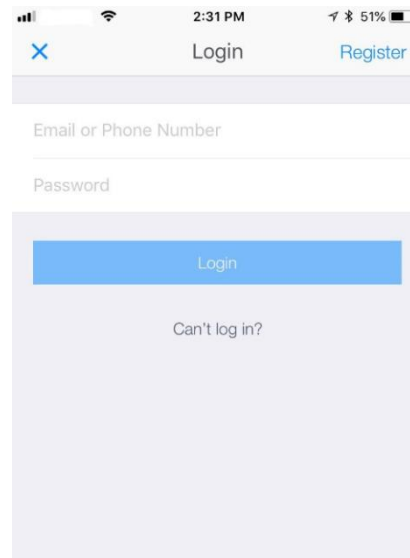

8.2.3 Create Plant

1. After login, click [+] in the upper right corner and follow the on-screen instructions. Then scan the serial number of the stick logger, or manually enter the serial number.

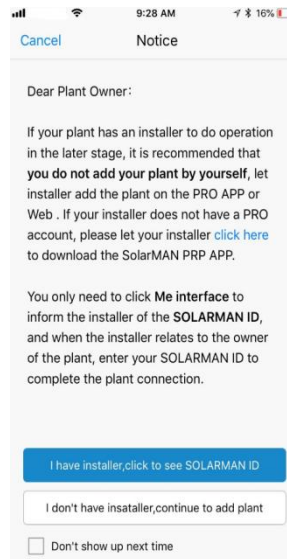

2. Edit Plant Information

- Confirm your plant location. GPS function will automatically locate the plant site. If you want to modify the location, click the [map] icon , and then manually enter the plant address.
- Select your plant type.
- Select your grid type.
- Fill in plant capacity.
(You may keep the default settings in the rest of blank because App has received local electricity prices and subsidies)

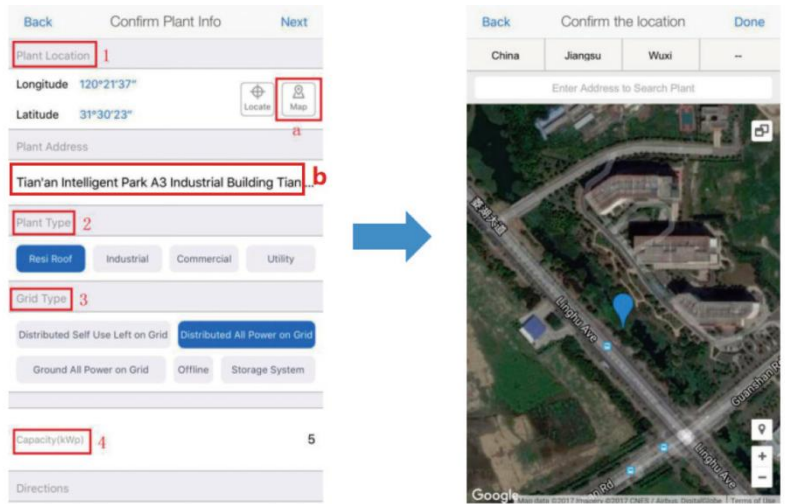

3. Enter the plant name. It is suggested to create a plant name like “location + name + capacity”, then click on [Done].



4. Then the plant you added is listed on the homepage.

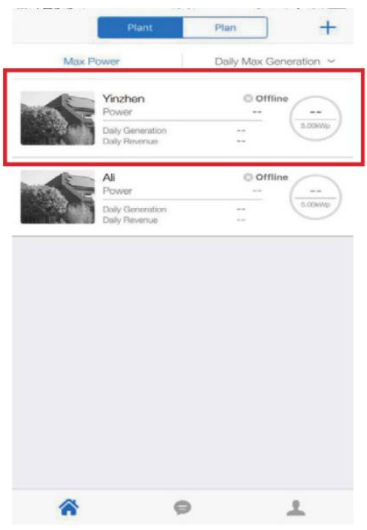

9 Troubleshooting for Fault Messages Displayed on APP

Fault Messages	Description	Corrective Action
Grid overvoltage / undervoltage	Voltage on AC side exceeds the allowable range	Check if the grid voltage is within the allowable range. Contact the local operation and maintenance personnel for any help.
Grid over-frequency / under-frequency	Frequency on AC side exceeds the allowable range	Check if the grid frequency is within the allowable range. Contact the local operation and maintenance personnel for any help.
No grid	Fail to detect the voltage on AC side	Check the connection of AC circuit breaker, AC fuse and AC terminals. Contact the local operation and maintenance personnel for any help.
PV reversely connected	Positive and negative polarity of DC input PV 1 or PV 2 are reversely connected	Contact the local operation and maintenance personnel for any help.
PV overvoltage	DC input voltage is excessive	Contact the local operation and maintenance personnel for any help.
Insulation impedance fault	Ground impedance of PV modules is less than the allowable value	Check the connection of PV arrays and earth wire, then restart the inverter. Contact the local operation and maintenance personnel for any help.
Leakage current abnormality	Leakage current exceeds the allowable value	Check the connection of PV arrays and earth wire, then restart the inverter. Contact the local operation and maintenance personnel for any help.