



MV110-8A

**Analog input module
8 channel**

User guide

Contents

1	Description	2
1.1	Function	2
1.2	RS485 network	2
1.3	Design.....	3
2	Specifications	4
2.1	Environmental conditions.....	5
3	Safety	6
3.1	Intended use	6
4	Installation	7
4.1	Wiring.....	7
4.1.1	Inputs	7
4.1.2	Resistance thermometer.....	8
4.1.3	Thermocouples	9
4.1.4	Current / voltage signals.....	9
4.1.5	Resistance sensor	9
4.1.6	Digital signals.....	10
4.1.7	Different input signals	10
5	Configuration	11
6	Operation	14
6.1	Signal processing	14
6.1.1	Sampling.....	14
6.1.2	Cold junction compensation.....	14
6.1.3	Linear signal	14
6.1.4	Digital Filter	14
6.1.5	Correction	15
6.2	Modbus communication.....	16
6.3	Error diagnosis.....	17
7	Factory settings restoration	18
8	Maintenance	20
9	Transportation and Storage	21
10	Scope of delivery	22
	Appendix A Dimensions	23

Description

1 Description

1.1 Function

Analog input module MV110-8A is an extension module with 8 universal analog inputs. The module provides following functions:

- analog-digital conversion
- sensors status diagnostic
- RS485 network status diagnostic
- error and alarm signals
- Slave device in Modbus structure

The module supports Modbus RTU, Modbus ASCII protocols with automatic protocol identification.

The module is to be configured using 'M110 Configurator' software (included on CD) via RS485-USB interface adapter (not included).

1.2 RS485 network

I/O modules of Mx110 series use common standard RS485 for data exchange. RS485 serial interface is based on two-wire technology and half-duplex mode. Protocols Modbus RTU, Modbus ASCII and akYtec are supported. The network consists of a master device and can contain up to 32 slave devices. The maximum length is 1200 m. The number of slave devices and the network length can be increased using a RS485 interface repeater.

Devices are connected to a network according to linear (bus) topology. It means that the line goes from the first device to the second one, from the second one to the third one, etc. Star connections and spur lines are not allowed.

Line reflections always occur at the open bus ends (the first and the last node). The higher the data transmission rate, the stronger they are. A terminating resistor is needed to minimize reflections. Experience proves that the most efficient practice is to use terminating resistors of 150 ohm.

The module can be used as slave devices only. Master device can be PLC, PC with SCADA software or control panel.

Description

1.3 Design

- Enclosure: plastic, grey, for DIN-rail or wall mounting
- Terminal blocks: 2 plug-in terminal blocks with 24 screw terminals
- LED „POWER“: power supply indicator
- LED „RS-485“: flashes at data exchange via RS485 interface

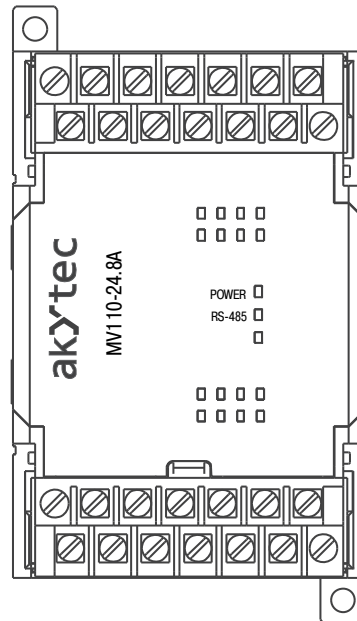

Fig. 1.1 Front View

Dimensional Sketches are given in Appendix A.

Under the cover on the front panel of the module there are three jumpers (refer to Figure 4.1):

- S1 Factory settings (see sec. 7)
- S2 Service function
- S3 Service function

All 3 jumpers are not inserted as supplied.

Specifications

2 Specifications

Table 2.1 General Specifications

Power supply		24 (20...28) V DC
Power consumption, max.		6 W
Inputs	digital	–
	analog	8
Outputs	digital	–
	analog	–
Sampling time for each input (max) ⁽¹⁾	RTD	0.9 s
	TC	0.6 s
	Standard I/U signals	0.6 s
RS485 interface	Terminals	D+, D-
	Protocols	Modbus RTU/ASCII, akYtec
	Baud rate	2.4...115,2 kbit/s
	Data bits	7, 8
	Parity control	even, odd, none
	Stop bits	1, 2
Dimensions		63 x 110 x 75 mm
Weight		approx. 240 g
Material		plastic

⁽¹⁾ Because the sampling of inputs is performed sequentially, the total sampling time is equal to the sum of the times of all connected inputs.

Table 2.2 Standard I/U signals

Signal type	Measurement range, %	Accuracy, %
Digital signal	available	
Standard signals		
0-1 V	0...100	±0.25
-50...+50 mV	0...100	
0-5 mA	0...100	
0-20 mA	0...100	
4-20 mA	0...100	
Position encoders		
Resistance sensor 25-900 ohm	2.8 ⁽¹⁾ ...100	±0.25
Resistance sensor 25-2000 ohm	1.26 ⁽¹⁾ ...100	
0(4)-20 mA	0...100	
0-5 mA	0...100	

⁽¹⁾ The range from 0 to 25 ohm is valued as a short circuit (see 6.3 Error Diagnosis).

Table 2.3 Supported Input Signals

Signal type	Measurement range, °C	Temperature coefficient, °C ⁻¹	Accuracy, %
RTD according to IEC 60751:2008			
Pt50	-200...+850	0.00385	±0.25
Pt100	-200...+850		
Pt500	-200...+850		
Pt1000	-200...+850		
RTD according to GOST 6651			
50P	-200...+750	0.00391	±0.25
50M	-190...+200	0.00428	

Specifications

Signal type	Measurement range, °C	Temperature coefficient, °C ⁻¹	Accuracy, %
Cu50	-50...+200	0.00426	
100P	-200...+750	0.00391	
100M	-190...+200	0.00428	
Cu100	-50...+200	0.00426	
Ni100	-60...+180	0.00617	
500P	-200...+750	0.00391	
500M	-190...+200	0.00428	
Cu500	-50...+200	0.00426	
Ni500	-60...+180	0.00617	
1000P	-200...+750	0.00391	
1000M	-190...+200	0.00428	
Cu1000	-50...+200	0.00426	
Ni1000	-60...+180	0.00617	
Cu53	-50...+200	0.00426	
TC according to IEC 60584-1:2013			
J	-200...+1200	-	±0,5
N	-200...+1300	-	
K	-200...+1300	-	
S	0...+1750	-	
R	0...+1750	-	
B	+200...+1800	-	
A	0...+2500	-	
T	-200...+400	-	
TC according to GOST 8.585			
L	-200...+800	-	±0,5
A-2	0...+1800	-	
A-3	0...+1800	-	

2.1 Environmental conditions

The module is designed for natural convection cooling. It should be taken into account when choosing the installation site.

The following environment conditions must be observed:

- clean, dry and controlled environment, low dust level
- closed non-hazardous areas, free of corrosive or flammable gases





Table 2.4 Environmental conditions

Condition	Permissible range
Ambient temperature	-20...+55°C
Transportation and storage	-25...+55°C
Relative humidity	up to 80% (at +25°C, non-condensing)
IP code	IP20
Altitude	up to 2000 m above sea level

Safety

3 Safety

Explanation of the symbols and keywords used:

 DANGER	<i>DANGER indicates an imminently hazardous situation which, if not avoided, will result in death or serious injury.</i>
 WARNING	<i>WARNING indicates a potentially hazardous situation which, if not avoided, could result in death or serious injury.</i>
 CAUTION	<i>CAUTION indicates a potentially hazardous situation which, if not avoided, could result in minor or moderate injury.</i>
 NOTICE	<i>NOTICE indicates a potentially harmful situation which, if not avoided, may result in damage of the product itself or of adjacent objects.</i>

3.1 Intended use

The device has been designed and built solely for the intended use described in this guide, and may only be used accordingly. The technical specifications contained in this guide must be observed.

The device may be operated only in properly installed condition.

Improper use

Any other use is considered improper. Especially to note:

- This device should not be used for medical devices which receive, control or otherwise affect human life or physical health.
- The device should not be used in an explosive environment.
- The device should not be used in an atmosphere with chemically active substance.

4 Installation

 **WARNING**

Improper installation

Improper installation can cause serious or minor injuries and damage the device. Installation must be performed only by fully qualified personnel.

- The device is intended to be mounted in a cabinet on DIN-rail or on the wall. For the dimension drawings see Appendix A.
- Install the module in a clean, dry and controlled environment. Further requirements are described in paragraph 2.1.
- The module is designed for convective self-cooling. This should be taken into account when selecting the installation site.

4.1 Wiring

 **WARNING**

Dangerous voltage

Electric shock could kill or seriously injure.

All electrical connections must be performed by a fully qualified electrician.

Ensure that the mains voltage matches the voltage marked on the nameplate!

Ensure that the device is provided with its own power supply line and electric fuse!

 **NOTICE**

Switch on the power supply only after the wiring of the device has been completely performed.

- Terminal connections are shown in Fig. 4.1, terminal assignments are given in Table 4.1.
- The inputs should be wired in accordance with Fig. 4.2 – 4.7.
- Connect the supply voltage to the terminals 24V and 0V.
- The maximum wire cross-section for power supply is 1.5 mm²

 **NOTICE**

EMC-safety

Signal cables should be routed separately or screened from the supply cables

Only shielded cable may be used for data transmission and signal lines.

Shield in the control cabinet for best electromagnetic immunity recommended.

- Connect RS485 line to terminals D+ and D-.
- Use twisted pair cable for RS485 connection. The length of the line should not exceed 1200 m.

4.1.1 Inputs

Valid signals (see Table 2.2):

- Dry contacts
- Standard current / voltage signals
- Resistance/ current position sensor
- Thermocouples
- Resistance thermometer

The following must be observed:

- All AI-R terminals are internally connected.
- The total resistance of sensor output with connection lines must not exceed 100 ohm.

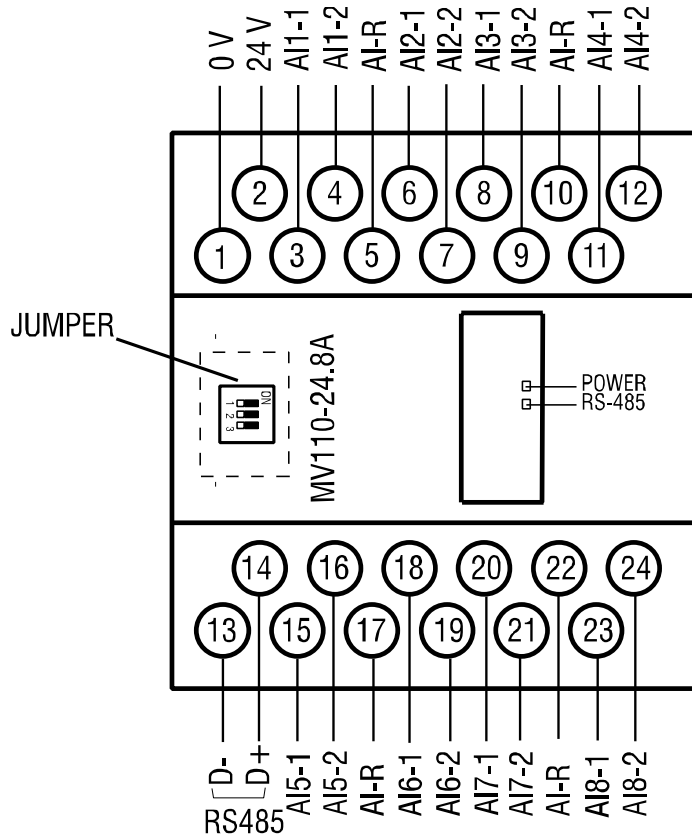

Fig. 4.1 Electrical connections

Table 4.1 Terminal assignments

No	Marking	Description	No	Marking	Description
1	0 V	Power supply	13	D-	RS485 D-
2	24 V	Power supply	14	D+	RS485 D+
3	AI1-1	AI1-1	15	AI5-1	AI5-1
4	AI1-2	AI1-2	16	AI5-2	AI5-2
5	AI-R	Common	17	AI-R	Common
6	AI2-1	AI2-1	18	AI6-1	AI6-1
7	AI2-2	AI2-2	19	AI6-2	AI6-2
8	AI3-1	AI3-1	20	AI7-1	AI7-1
9	AI3-2	AI3-2	21	AI7-2	AI7-2
10	AI-R	Common	22	AI-R	Common
11	AI4-1	AI4-1	23	AI8-1	AI8-1
12	AI4-2	AI4-2	24	AI8-2	AI8-2

4.1.2 Resistance thermometer

Two- or three-wire sensors can be connected.

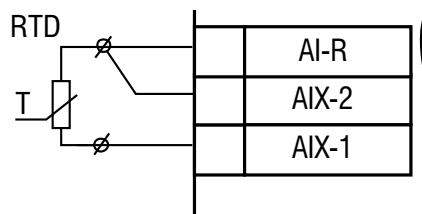

Fig. 4.2 RTD wiring

Installation

4.1.3 Thermocouples

Optional cold junction compensation is provided for connection of thermocouples.

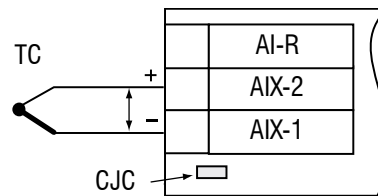

Fig. 4.3 Thermocouple wiring

► NOTICE

Only thermocouples with insulated and ungrounded measuring junction can be used, because AIX-1 terminal has equal potential.

4.1.4 Current / voltage signals

- When measuring current or voltage signals an external power supply should be taken into account.
- Voltage signal can be connected directly to the input terminals

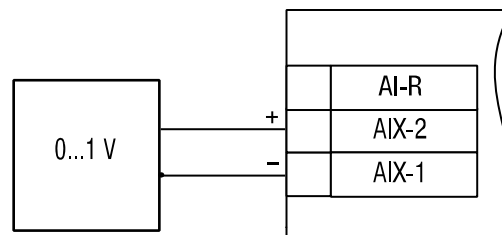

Fig. 4.4 Voltage signal wiring

- To measure a current signal a shunt resistance of 50 ohm ($\pm 1\%$) should be connected in parallel. It is recommended to use resistance included in the package or other high-stable resistance.

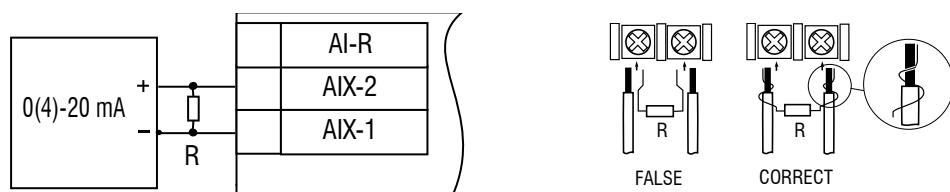

Fig. 4.5 Current signal wiring

► NOTICE

It is necessary to provide safe contact between signal wires and resistance wires; otherwise the input can be damaged.

4.1.5 Resistance sensor

- Resistance sensors can be connected directly to the input terminals

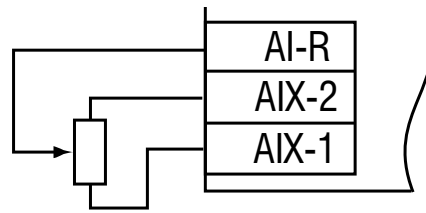

Fig. 4.6 Resistance sensor wiring

- 25-900 ohm and 25-2000 ohm resistance sensors are supported
- The range from 0 to 25 ohm is valued as a short circuit.

4.1.6 Digital signals

- Up to 16 digital signals can be connected to the module
- In order to connect digital signal, you need to connect shunt resistance from 200 Ohm to 3,000 Ohm in parallel.

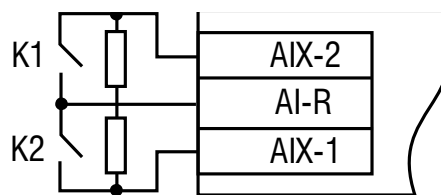

Fig. 4.7 Digital signal wiring

- In assessment of the input state, 4 different variants are distinguished. Assessment of these variants is presented in Table 4.2.

Table 4.2 Input status for digital signals

K1	K2	Input status
open	open	1
closed	open	2
open	closed	3
closed	closed	4

4.1.7 Different input signals

Each input can be configured for any type of signal individually. The signal type (sensor type) must be selected for **in-t** parameter. A full list of configuration parameters is presented in App. B.

Configuration

5 Configuration

► NOTICE

Before starting

Before switching on, make sure that the device has been kept at the specified ambient temperature (-20... +55 ° C) for at least 30 minutes.

The configuration tool 'M110 Configurator' allows viewing, editing and saving of parameters. The complete list of parameters is shown in Table 5.1.

The software and the manual are included on the CD.

The module must be configured in order to use it in RS485 network. Proceed as follows:

- install the configuration software 'M110 Configurator' on the PC
- connect the module to the USB interface of the PC over USB/RS485 adapter (not included)
- connect a power source 24V DC to the module terminals 24V/0V
- switch the power on
- run the M110 Configurator

If the factory settings of the module have not been changed, then connection with the module is established automatically. The module is automatically identified, the module configuration parameters are readout and a window with an appropriate configuration mask opens.

Otherwise, the network parameters of the configurator must be adapted.

Table 5.1 Configuration parameters

Name	Parameter	Permissible values	Significance	Default value
Basic parameters				
dev	Device	up to 8 characters		MV110-8A
ver	Firmware version	up to 8 characters		Manufacturer
exit	Exit code	0	software reset	-
		6	hardware reset	
		7	power on	
		8	watchdog timer	
Network parameters				
bPS	Baud rate, kbit/s	0	2.4	9.6
		1	4.8	
		2	9.6	
		3	14.4	
		4	19.2	
		5	28.8	
		6	38.4	
		7	57.6	
		8	115.2	
LEn	Data bits *	0	7	8
		1	8	
PrtY	Parity *	0	none	none
		1	even	
		2	odd	
Sbit	Stop bits *	0	1	1
		1	2	
A.Len	Address bits	0	8	8

Configuration

Name	Parameter	Permissible values	Significance	Default value
		1	11	
Addr	Device address	1...247		16
Rs.dL	Response delay, ms	0...45		2
Input parameters				
Cj-C	Cold junction compensation	0	off	off
		1	on	
in-t	Sensor type	00	off	off
		02	Cu 50 ($\alpha=0.00426$)	
		10	50M ($\alpha=0.00428$)	
		08	Pt50 ($\alpha=0.00385$)	
		09	50P ($\alpha=0.00391$)	
		01	Cu100 ($\alpha=0.00426$)	
		15	100M ($\alpha=0.00428$)	
		03	Pt100 ($\alpha=0.00385$)	
		04	100P ($\alpha=0.00391$)	
		30	Ni100 ($\alpha=0.00617$)	
		31	Cu500 ($\alpha=0.00426$)	
		32	500M ($\alpha=0.00428$)	
		33	Pt500 ($\alpha=0.00385$)	
		34	500P ($\alpha=0.00391$)	
		35	Ni500 ($\alpha=0.00617$)	
		36	Cu1000 ($\alpha=0.00426$)	
		37	1000M ($\alpha=0.00428$)	
		38	Pt1000 ($\alpha=0.00385$)	
		39	1000P ($\alpha=0.00391$)	
		40	Ni1000 ($\alpha=0.00617$)	
		16	Cu53 ($\alpha=0.00426$)	
		05	Type L	
		21	Type J	
		20	Type N	
		06	Type K	
		18	Type S	
		19	Type R	
		17	Type B	
		22	Type A	
		23	Type A-1	
		24	Type A-2	
		25	Type T	
13	0-5 mA			
12	0-20 mA			
11	4-20 mA			
07	-50...+50 mV			
14	0-1 V			
26	position 25-900 Ohm			
41	position 25-2000 Ohm			
27	position 0(4)-20 mA			
28	position 0-5 mA			
29	digital input			
in.Fd	Filter time constant, s	0...1800		0.0

Configuration

Name	Parameter	Permissible values	Significance	Default value
ltrl	Sampling period, s		0.3...30	0.5
in.SH	Characteristic offset		-999...9999	0.0
in.SL	Characteristic slope		0.9...1.1	1.0
in.FG	Filter pass band		0...9999	0.0
Ain.L	Lower limit		-999...9999	0.0
Ain.H	Upper limit		-999...9999	100
dP	Decimal point		0...3	1

* Invalid network parameter combinations:

- *prty=0; sbit=0; len=0*
- *prty=1; sbit=1; len=1*
- *prty=2; sbit=1; len=1*

6 Operation

The module is controlled by the master device in Modbus network.

Following Modbus functions are available: 03, 04 for reading and 15, 16 for writing.

6.1 Signal processing

Inputs are sampled cyclically. The measured values are converted into digital values, analyzed and processed in accordance with the set parameters. The results are saved in data registers (Table 6.1).

An analog input signal from the resistance thermometer or thermocouple is converted according to sensor curve into a standard signal. Standard signal is digitized and processed.

6.1.1 Sampling

An input is included into the sampling list if the signal type is selected. If the parameter **int** is set to OFF, then the input is excluded from the list.

The parameter **ltr1** specifies the sampling period in the range from 0.3 to 30 s for each input. If the lower limit of 0.3 s is not physically achievable, the sampling period is automatically increased to the lowest possible value.

6.1.2 Cold junction compensation

The precise temperature measurement using thermocouples is provided by cold junction compensation. A reference junction sensor is located near the input terminals. Set the parameter **Cj.C** to ON to enable this function. This setting is effective for all inputs.

Other filters and corrections for individual inputs are described in sections 6.1.4 and 6.1.5.

6.1.3 Linear signal

To scale the linear signal (current or voltage) the measurement limits must be set. Parameters **Ain.L** 'Lower limit' and **Ain.H** 'Upper limit' are set in physical.

If **Ain.L < Ain.H**, then

$$\text{Measured value} = \text{Ain.L} + \frac{(\text{Ain.H} - \text{Ain.L}) * (S_i - S_{\min})}{S_{\max} - S_{\min}}$$

If **Ain.L > Ain.H**, then

$$\text{Measured value} = \text{Ain.L} - \frac{(\text{Ain.L} - \text{Ain.H}) * (S_i - S_{\min})}{S_{\max} - S_{\min}}$$

where

S_{\max} – is the upper signal limit (for example, 20 for 4-20 mA signal)

S_{\min} – is the lower signal limit (for example, 4 for 4-20 mA signal)

S_i – is the actual signal value

6.1.4 Digital Filter

The digital filter consists of two stages.

A comparator is used at the first stage. The filter bandwidth for the comparator must be specified in parameter **in.FG** in physical units of measurement. The difference between the last two measurements is determined and compared with the bandwidth. If the difference is greater than the bandwidth, the measurement must be repeated. If an error has occurred during the first measurement, this is confirmed by the second measurement and the first measurement value is ignored as an error. If the bandwidth is set to '0', the comparator is switched off.

Operation

A damping is used at the second stage. The filter time constant must be set in parameter **in.fd** in seconds. The higher is the value, the higher is the noise resistance and the slower is the input response. When the value is set to '0', damping is switched off.

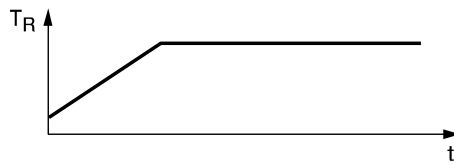

Fig. 6.1 Actual temperature T_R

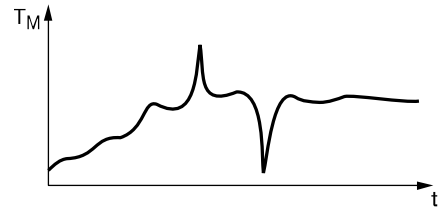

Fig. 6.2 Measured temperature T_M
(filter is OFF)

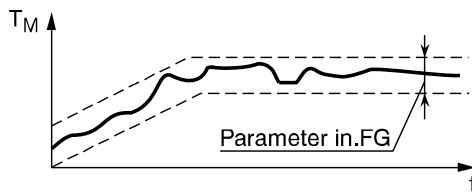

Fig. 6.3 Comparator is ON

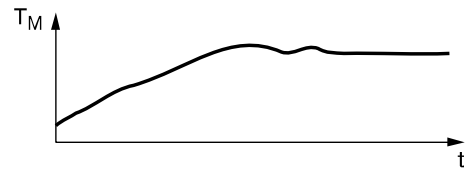

Fig. 6.4 Comparator and damping are ON

6.1.5 Correction

The characteristic curve of the sensor can be corrected by the user. Two correction parameters are provided for each input: the offset and the slope.

- Offset must be set with the parameter **in.SH** in physical units of measurement to correct the sensor initial error, for example, when you use a resistance thermometer.

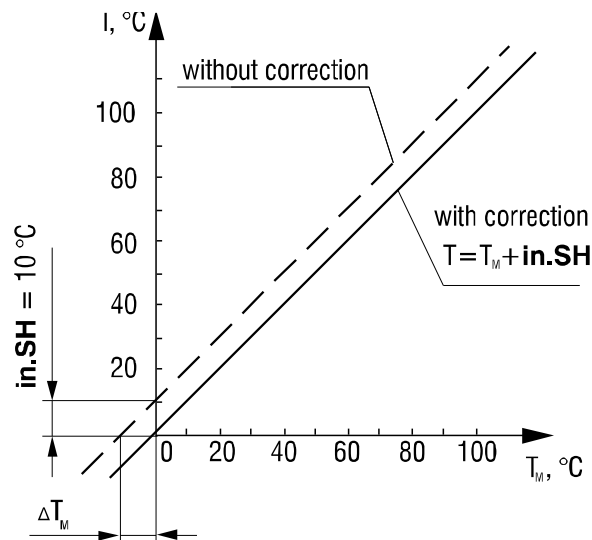

Fig. 6.5 Offset

- Slope is to be set with the parameter **in.SL** within the range from 0.9 to 1.1.

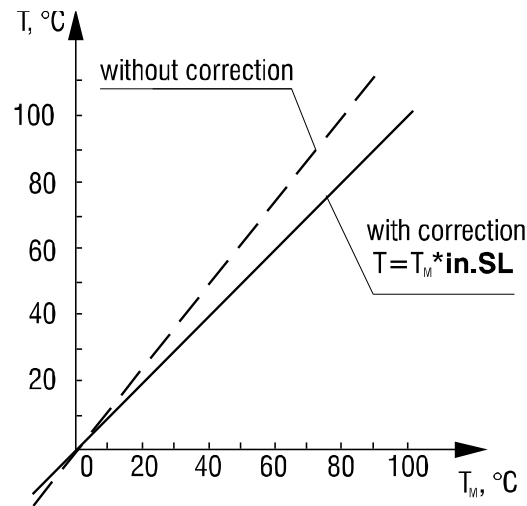

Fig. 6.6 Slope

6.2 Modbus communication

Modbus-RTU and Modbus-ASCII protocols are supported.

Modbus functions 03 and 04 for the following parameters are available:

- Measured value
- Time mark
- Error code (see 6.3)

The measured value is in two formats available:

- Integer (16 bits)
- Floating-point (32 bits)

Both formats are saved in different data registers (see Table 6.1).

The integer is calculated by multiplication of the measured value by 10^{dP} . The parameter **dP** is used for a decimal point and can be set within the range 0...3.

When a floating-point number value is transmitted, the most significant byte of 32-bit data is stored in the first register (big-endian).

The time mark is cyclic time within the range from 0 to 655.36 seconds with the increment of 0.01 second saved as a 2 byte integer. It determines the exact time of measurement within the cycle. When the module is powered on, the cycle starts from 0 and returns to the initial state in 655.36 seconds.

Table 6.1 Modbus registers

Input	Parameter	Data type	Register	
			hex	dec
1	Decimal point (dP)	INT16	0000	0
	Measured value	INT16	0001	1
	Error code	INT16	0002	2
	Time mark	INT16	0003	3
	Measured value as FLOAT	FLOAT32	0004, 0005	4, 5
2	Decimal point (dP)	INT16	0006	6
	Measured value	INT16	0007	7
	Error code	INT16	0008	8
	Time mark	INT16	0009	9
	Measured value as FLOAT	FLOAT32	000A, 000B	10, 11
...				

Operation

Input	Parameter	Data type	Register	
			hex	dec
8	Decimal point (dP)	INT16	002A	42
	Measured value	INT16	002B	43
	Error code	INT16	002C	44
	Time mark	INT16	002D	45
	Measured value as FLOAT	FLOAT32	002E, 002F	46, 47

6.3 Error diagnosis

When polling inputs, the module controls the status of the connected sensors, the correctness of communication and the measurement. The detected errors are transmitted with the response as an error code (see Table 6.2).

If there is a measurement error, the last correctly saved value is transmitted.

The range from 0 to 25 Ohm for resistance sensors is considered to be a short circuit.

Table 6.2 Error Codes

Error	Comment	Code
Measurement correct	Transmission in progress	0x0000
Measured value error	Measured value incorrect (linear signal)	0xF000
Measurement not ready	Just upon restart	0xF006
Sensor switched off	in-t parameter set to OFF	0xF007
Cold junction temperature too high	>90°C	0xF008
Cold junction temperature too low	<-10°C	0xF009
Measured value too high	Exceeded the measuring range of the selected sensor type	0xF00A
Measured value too low	Below measuring range of the selected sensor type	0xF00B
Short circuit	Resistance thermometer, resistance sensor	0xF00C
Sensor break	Resistance thermometer, thermocouple, live zero linear signal	0xF00D
No connection with A/D converter	Hardware error	0xF00E
Calibration error	Calibration incorrect	0xF00F

Factory settings restoration

7 Factory settings restoration

If communication between the PC and the module cannot be established and the network parameters of the module are unknown, the factory settings of the network parameters must be restored. Proceed as follows:

- power off the module
- remove the left cover from the front panel of the module
- turn the DIP switch S1 in ON position
- now the module is operated with default network parameters, the user settings are saved
- switch the power on

Dangerous voltage

Electric shock could kill or seriously injure.

The voltage on some components of the circuit board can be dangerous! Direct contact with the circuit board or penetration of a foreign body in the enclosure must be avoided!



WARNING

- start the 'M110 Configurator' software
- in the 'Connection to device' window set the parameters to default (see Table 7.1) or click the 'Use factory settings' button (see Fig. 7.1)

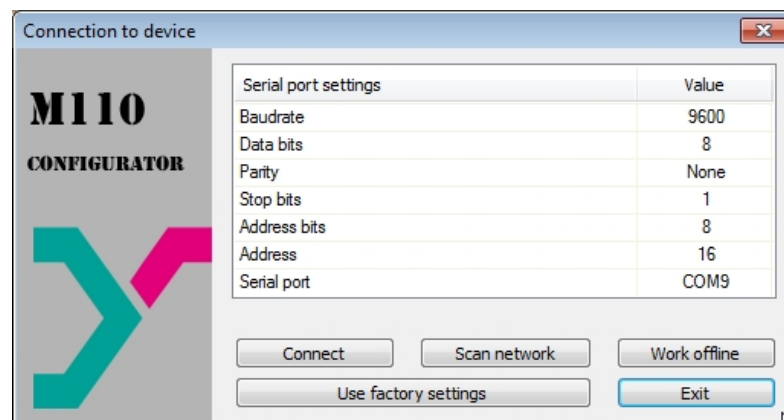

Fig. 7.1 Start window of configuration software

- press 'Connect' button
- connection is established with the default network parameters.
- the main window of the configurator opens
- now the saved network parameters of the module can be read out (see Fig. 7.2)
- open the 'Network parameters' folder in the configuration tree, read and note down the values of the network parameters
- close the Configurator
- switch the power off

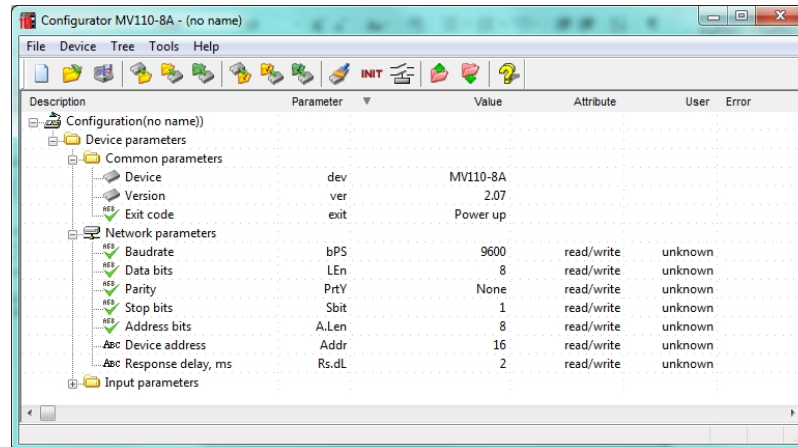

Fig. 7.2 Main window of M110 Configurator

- turn the DIP switch S1 in OFF position
- close the cover
- switch the power on
- start the Configurator
- enter the written network parameters
- press 'Connect' button

The module is ready for operation.

Table 7.1 Network factory settings

Parameter	Name	Default
Baud rate	bps	9600
Data bits	len	8
Parity	prty	none
Stop bits	sbit	1
Address bits	a.len	8
Address	addr	16
Response delay, ms	rs.dl	2

Maintenance

8 Maintenance

The maintenance includes:

- cleaning of the housing and terminal blocks from dust, dirt and debris
- check the device fastening
- checking the wiring (connecting leads, fastenings, mechanical damage)

The device should be cleaned with a damp cloth only. No abrasives or solvent-containing cleaners may be used. The safety information in section 3 must be observed when carrying out maintenance.

Transportation and Storage

9 Transportation and Storage

Pack the device in such a way as to protect it reliably against impact for storage and transportation.

The original packaging provides optimum protection.

If the device is not taken immediately after delivery into operation, it must be carefully stored at a protected location. The device should not be stored in an atmosphere with chemically active substances.

Permitted storage temperature: -25...+55 °C

► NOTICE

Transport damage, completeness

The device may have been damaged during transportation.

Check the device for transport damage and completeness!

Report the transport damage immediately to the shipper and akYtec GmbH!

Scope of delivery

10 Scope of delivery

- Module MV110-24.8A	1
- User guide	1
- CD with software and documentation	1
- Shunt resistance 50 ohm	8

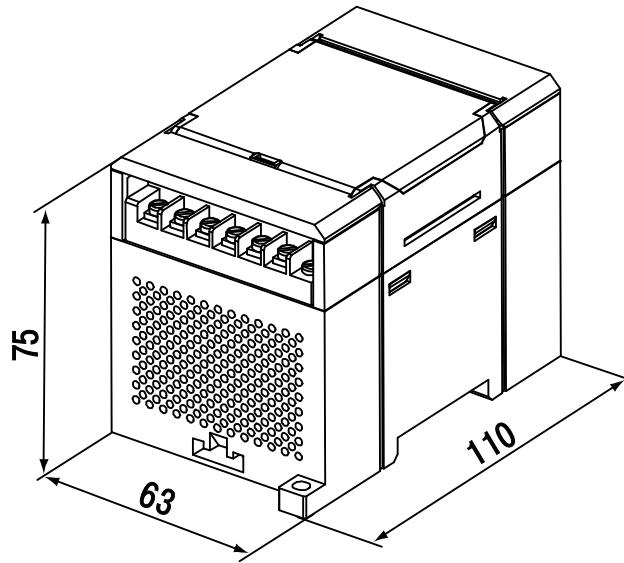

Fig. A.1 External dimensions

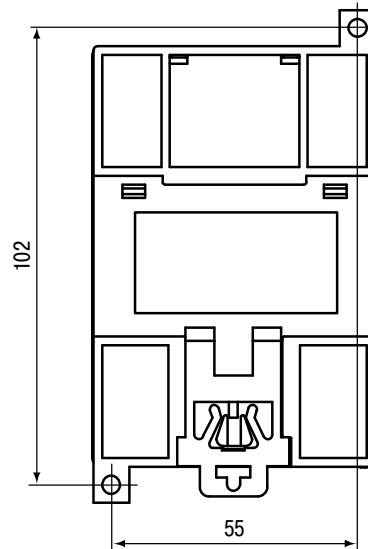

Fig. A.2 Wall mounting dimensions

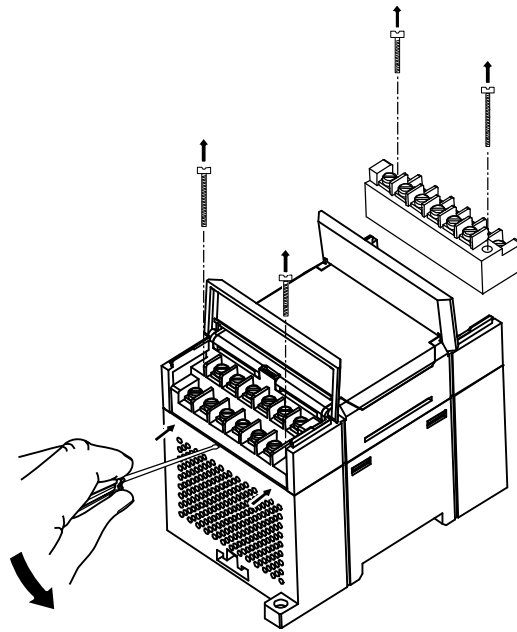

Fig. A.3 Replacement of terminal blocks